

rossmax



Model:
AC1000 f

EN

Instruction Manual

www.rossmax.com

Table of Contents:

Introduction	2
Cautionary Notes	3
Notes on Safety	4
Name/Function of Each Part	6
Monitor Installation - Trolley (Optional)	7
Real Fuzzy Measuring Technology	8
Preliminary Remarks	8
Display Explanations	9
How to Use the POWER Source	10
Applying the Cuff	14
Measurement Procedures	17
Setting Deflation Rate	18
Recalling Values from Memory	19
Clearing Values from Memory	19
How to clean the unit after use	19
Troubleshooting	20
Specifications	21
EMC guidance and manufacturer's declaration.....	22

Introduction

Blood pressure measurements determined with AC1000f are equivalent to those obtained by a trained observer using cuff/stethoscope auscultation method, within the limits prescribed by the American National Standard, Electronic or Automated Sphygmomanometers. This unit is to be used by adult consumers in physicians' offices, hospitals, clinics and other medical facilities. Do not use this device on infants or neonates. AC1000f is protected against manufacturing defects by an established International Warranty Program. For warranty information, you can contact the manufacturer, Rossmax International Ltd.

Attention: Consult the accompanying documents. Please read this manual carefully before use. For specific information on your own blood pressure, contact your physician. Please be sure to keep this manual.



Cautionary Notes

1. The unit contains high-precision assemblies. Therefore, avoid extreme temperatures, humidity, and direct sunlight. Avoid dropping or strongly shocking the main unit, and protect it from dust.
2. Leaky batteries can damage the unit. Remove the batteries when the unit is not used for a long time.
3. The unit should not be operated by children so to avoid hazardous situations.
4. If the unit is stored near freezing, allow it to acclimate at room temperature before use.
5. This unit is not field serviceable. You should not use any tool to open the device nor should you attempt to adjust anything inside the device. If you have any problems, please contact the store or the doctor from whom you purchased this unit or please contact Rossmax International Ltd.
6. As a common issue for all blood pressure monitors using the oscillometric measurement function, the device may have difficulty in determining the proper blood pressure for users diagnosed with common arrhythmia (atrial or ventricular premature beats or atrial fibrillation), diabetes, poor circulation of blood, kidney problems, or for users suffered from stroke, or for unconscious users.
7. To stop operation at any time, press the START/STOP and ON/OFF key, and the air in the cuff will be rapidly exhausted.
8. Once the inflation reaches 300 mmHg, the unit will start deflating rapidly for safety reasons.
9. Electromagnetic interference: The device contains sensitive electronic components. Avoid strong electrical or electromagnetic fields in the direct vicinity of the device (e.g. mobile telephones, microwave ovens). These may lead to temporary impairment of measurement accuracy.
10. Dispose of device, batteries, components and accessories according to local regulations.
11. This monitor may not meet its performance specification if stored or used outside temperature and humidity ranges specified in Specifications.

Notes on Safety

Warning:



- Self diagnosis of measured results or treatment is dangerous. Please follow the instruction of the doctor or healthcare provider.
- If cuff inflation does not stop, remove the cuff or pull out the air tube from the main unit.
- If battery fluid gets into your eye or comes in contact with skin, wash the effected area with water repeatedly. Immediately consult a doctor for treatment.
- Do not wrap the cuff over an arm to which intravenous injection or transfusion is being conducted, or when otherwise contraindicated.
- Do not connect the air tube or the cuff to other equipment which is connected to an intra corporeal organ. Air embolisms may result.
- Do not use this unit in the presence of flammable gas or anesthetics or in a high pressure oxygen room or oxygen tent.
- Do not use the battery pack for devices other than for this unit.
- Do not disassemble the battery.
- Do not touch the AC adaptor with wet hands.
- Do not use any cuff other than the models exclusive for this unit.
- Do not use this unit on infants.
- Do not use this unit on patients using a pump oxygenator.
- Do not use an AC adaptor or battery pack no specified for this unit.
- Do not use a cellular pone near this unit.
- Do not use this unit in a vehicle.
- Do not install the parts and/or instruments not specified for this unit.
- Do not use a broken power cord or AC adaptor.
- Do not install or store this unit where it may come in contact with water or liquid medication.
- This is a Class II device with double insulation.

General advice:

- Do not place or put anything on this unit.
- Do not drop this unit.
- Turn off power to the unit and unplug the AC adaptor from the electric outlet before moving the unit.
- Read the instruction manual of the other devices to be used at the same time with this unit, to understand and be aware of the interaction between the devices.
- When using the unit:
 - Do not inflate the cuff without being wrapped over the arm.
 - Do not use a damaged cuff.
 - Be sure that patients do not touch the buttons of this unit.
- After using the unit:
 - Do not disinfect this unit by autoclave or gas sterilization (EtO, glutaraldehyde, or high concentration ozone).
- Do not install or store this unit in the following places.
 - Under the direct sunlight.
 - Dusty or salty environment.
 - Places having slope or where combustible gas may be generated.
 - Under high temperature and high humidity.

Name/Function of Each Part

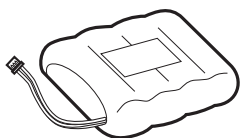
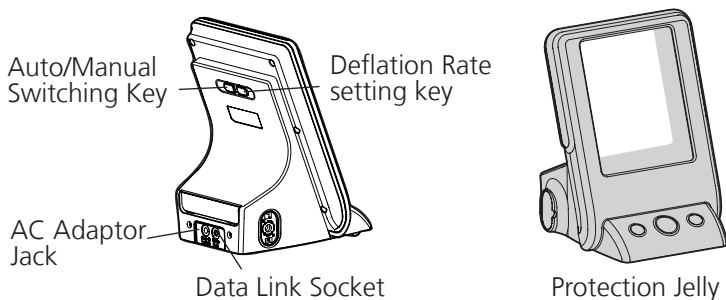
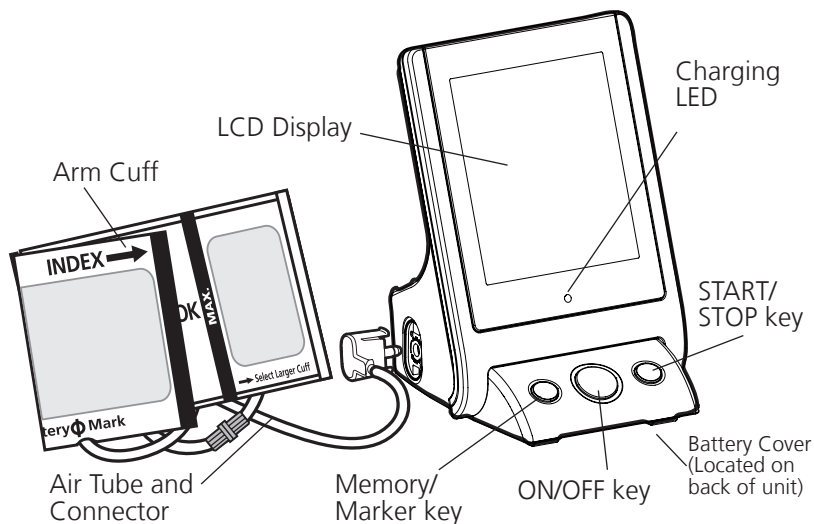

Battery Pack:
4.8V, 1700mAh
NIMH Battery

Monitor Installation - Trolley (Optional)

Placing Protection Jelly
onto the Monitor

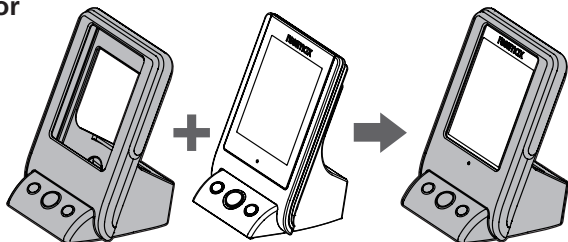

Installing Monitor
on the Trolley

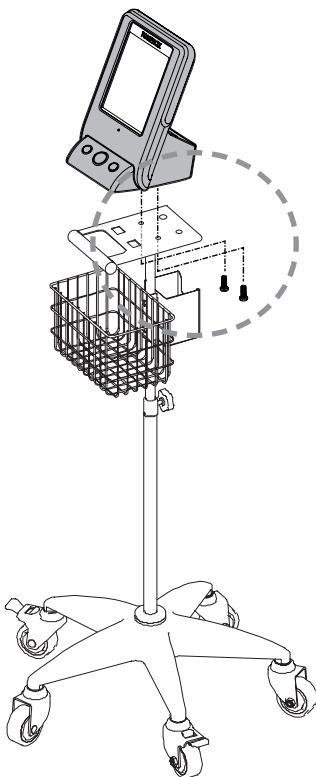

Real Fuzzy Measuring Technology

This unit uses the oscillometric method to detect your blood pressure. Before the cuff starts inflating, the device will establish a baseline cuff pressure equivalent to the air pressure. This unit will determine the appropriate inflation level based on pressure oscillations, followed by cuff deflation.

During the deflation, the device will detect the amplitude and slope of the pressure oscillations and thereby determine for you the systolic blood pressure, diastolic blood pressure, and pulse.

Preliminary Remarks

This Blood Pressure Monitor complies with the European regulations and bears the CE mark "CE 0120". The quality of the device has been verified and conforms to the provisions of the EC council directive 93/42/EEC (Medical Device Directive), Annex I essential requirements and applied harmonized standards.

EN 1060-1: 1995/A2: 2009 Non-invasive sphygmomanometers - Part 1 - General requirements

EN 1060-3: 1997/A2: 2009 Non-invasive sphygmomanometers - Part 3 - Supplementary requirements for electro-mechanical blood pressure measuring systems

EN 1060-4: 2004 Non-invasive sphygmomanometers - Part 4: Test Procedures to determine the overall system accuracy of automated non-invasive sphygmomanometers.

This blood pressure monitor was designed for long service time. To ensure continued accuracy, it's recommended that all digital blood pressure monitors require re-calibration. The monitor does not require re-calibration for 2 years, at which time your monitor displays **CR**. The unit should also be re-calibrated if the monitor sustains damage due to blunt force (such as dropping) or exposure to fluids and / or extreme hot or cold temperature / humidity changes. When **CR** appears, simply return to your nearest dealer for re-calibration service.



Display Explanations

Display:

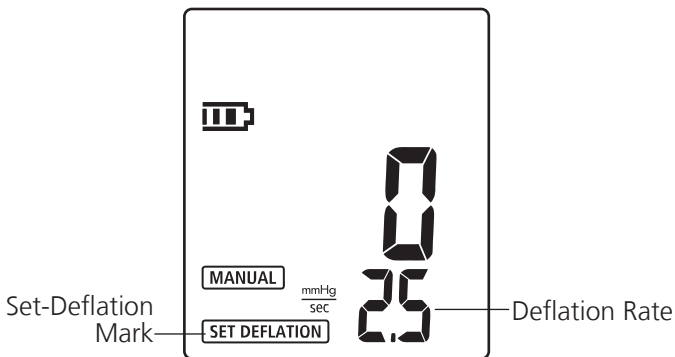
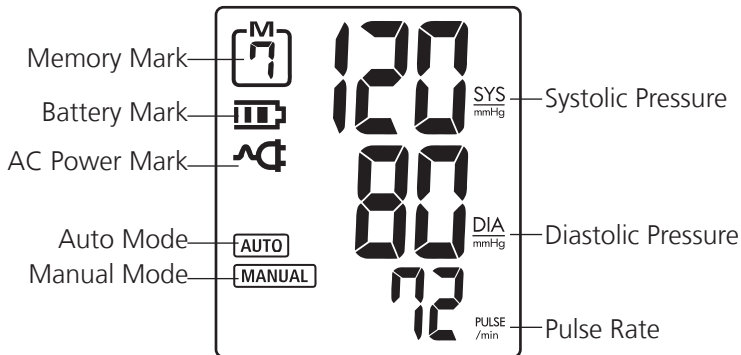

Display Explanations

Icons:

EE **Measurement Error:** Make sure the L-plug is securely connected to the air socket and measure again. Wrap the cuff correctly and keep arm steady during measurement. If the error keeps occurring, return the device to your local distributor or service center.

E1 **Air Circuit Abnormality:** Make sure the L-Plug is securely connected to the air socket on the side of the unit and measure again. Another possible cause can be due to the short circuit of the microphone embedded in the cuff. If the errors still occur, return the device to your local distributor or service center for help.

E2 **Pressure Exceeding 300 mmHg:** Switch the unit off and measure again. If the error keeps occurring, return the device to your local distributor or service center.

E3 **Data Error:** Remove the batteries, wait for 60 seconds, and reload. If the error keeps occurring, return the device to your local distributor or service center.

Er **Exceeding Measurement Range:** Measure again. If the error keeps occurring, return the device to your local distributor or service center.





CR **Calibration Indicator:** Appears when the monitor requires re-calibration.

How to Use the POWER Source

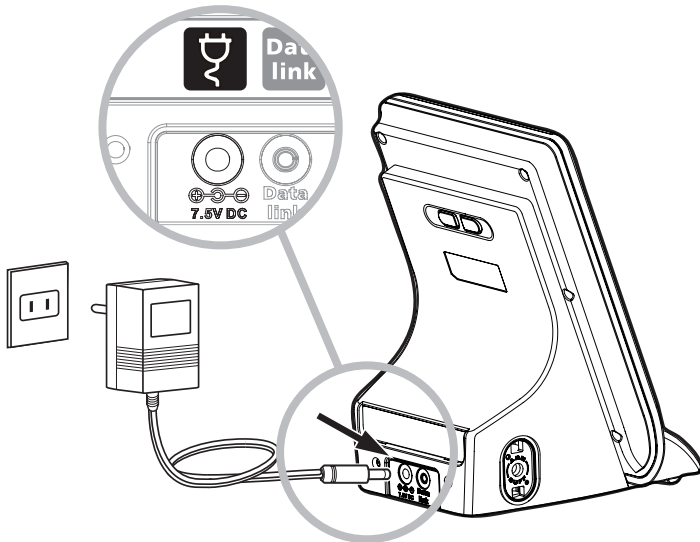
How to Use the AC Adaptor

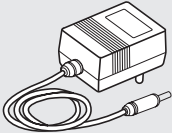
1. Connect the AC adaptor with the AC adaptor jack in the back of the unit.
2. Plug the AC adaptor into the socket. Please use the compatible AC adaptors. (AC adaptors with required voltage and current indicated near the AC adaptor jack.)



AC Adaptor		Adaptor Information	
		MODEL: HK-X111-A075	
(Ø3.8 / Ø1.35)		HK-X211-A075	
		Input: 100-240V~50/60Hz 0.8A	
		Output: 7.5V  1.5A	
		Brand: ROSSMAX	
		Manufacturer: HON-KWANG	

- When using the battery pack and connect the AC adaptor, the unit also functions as the charger.

Note: The AC adaptor can use with unit individually. (without battery pack).

Warning:



- Do not use this unit in places where inflammable gas, such as highly inflammable anesthetic, may be generated or in a high pressure oxygen room or an oxygen tent. It may cause ignition and explosion.
- Do not touch the AC adaptor with wet hands. You may suffer electric shock.

Caution:



- Be sure to use the AC adaptor appropriate for your country. It may cause fire or you may suffer electric shock.
- Do not install or store this unit where it may be sprayed with water or medication. You may suffer electric shock.

General advice:

- Read the instruction manual of the other advices to be used at the same time with this unit to understand and be aware of the interaction between the devices.

Installation and Replacement of Battery Pack

Warning:



- If the fluid in the battery gets into your eye, wash the eye with sufficient water without rubbing the eye, then immediately consult the doctor for treatment. There is danger in losing your eyesight.
- Do not use the exclusive battery pack other than for this unit.
- Do not throw the battery pack into fire, or heat, or disassemble it. It may cause heat, ignition, short-circuit, or rupture.

Caution:



- Do not short-circuit the polarities of the optional battery pack with a metal object such as wire.
- If the fluid in the battery is stained on your skin or clothes, immediately wash off the fluid with water. You may suffer injury, or the battery may leak, heat, ignite fire, or explode.

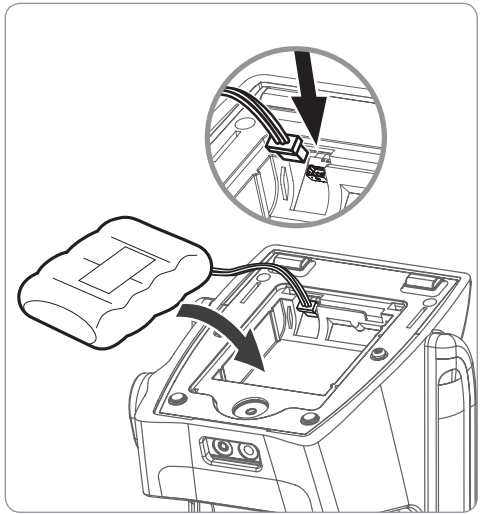
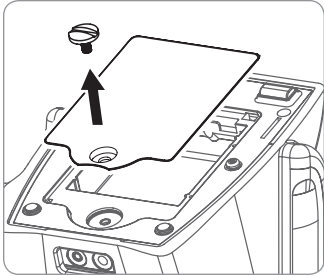
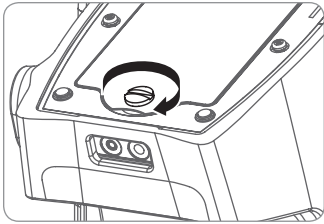

1. Remove the screw on the battery cover (Located on back of unit) of this unit.
2. **Installation:** Connect the battery pack to the connector in the battery cover to install it.
Replacement: Disconnect the battery pack from the connector and replace with a new one.
3. Install the battery cover and fasten it with screws. At this time, be careful not to pinch the lead wire.
4. Connect the main unit and the AC adaptor, then charge the battery pack. The battery pack is not charged when you purchase the monitor. When you use the battery pack for the first time, charge it for more than twelve hours before use.

Battery life:

- You can use the unit for approximately six hundred measurements with one charge.
- Approximate life of battery pack is two years. However the battery pack life from each charging may be shortened depending on the state of using.

Charging time:

- After connecting the AC adaptor, the battery pack will start charging automatically.
- While the battery is being charged, the  and battery marks turn on and LED shows orange light.
- While the charging is completed, LED shows green light.

Battery low:

- If a  mark is displayed, the battery is low (blood pressure cannot be measured). Please charge the battery.



Automatic Power Off:

- If you use the unit with the battery pack only, the unit will turn off automatically in approximately five minutes even if you forget to turn off the power.
- While the AC adaptor is connected, the Auto Power Off function does not work.



Applying the Cuff

1. Select cuff according to arm size:

Rossmax Cuff size	Arm circumference	
L size	34~46 cm (13.4"~18.1")	
M size	24~36 cm (9.4"~14.2")	
S size	16~26 cm (6.3"~10.2")	

2. Connect the air tube securely.

- Connect the air tube to the main unit by securing the air plug to the base of the air connector.
- Securely connect the air tube and the cuff set by rotating Luer connector.

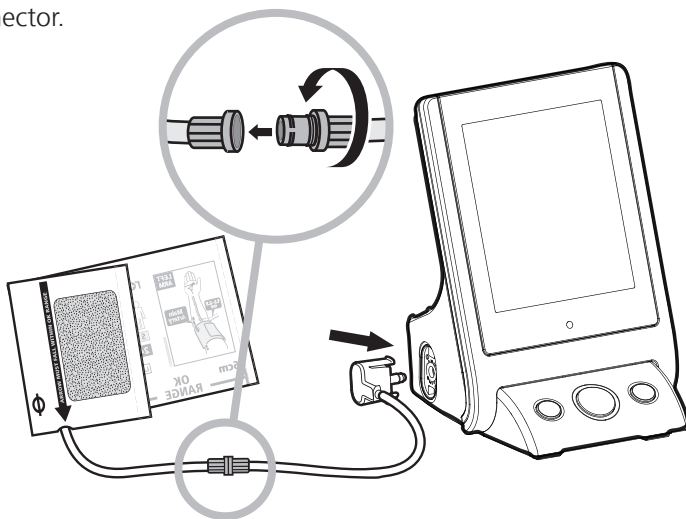

3. Place the cuff over the bare upper arm, wrap it with the tube pointing your palm, and the artery mark over your main artery.

4. The edge of the cuff should be at approximately 1.5 to 2.5 cm above the inner side of the elbow joint. If the index line falls within the range of the arm circumference indicator, the cuff circumference is suitable, otherwise you may need a cuff with a different circumference.

5. Center the tube over the middle of the arm. Press the hook and loop material together securely. Allow room for 2 fingers to fit between the cuff and your arm. Position the artery mark (Ø) over the main artery (on the inside of your arm).

Note: Locate the main artery by pressing with 2 fingers approximately 2 cm above the bend of your elbow on the inside of your left arm. Identify where the pulse can be felt the strongest. This is your main artery.

6. Lay your arm on a table (palm upward) so the cuff is at the same height as your heart. Make sure the tube is not kinked.

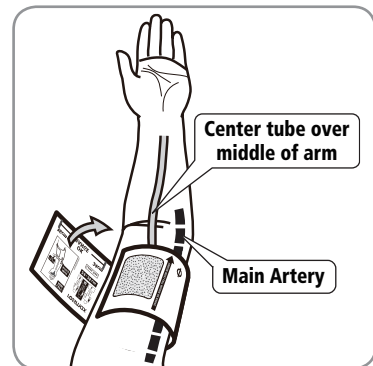
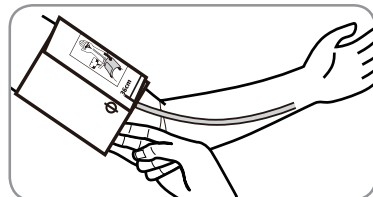
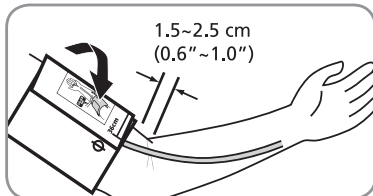
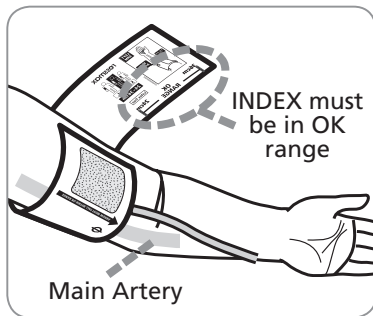

Manual Mode (with Stethoscope)

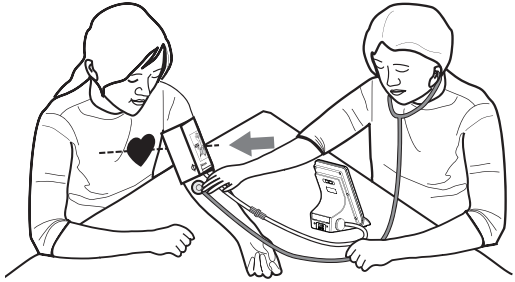

Auto Mode (without Stethoscope)

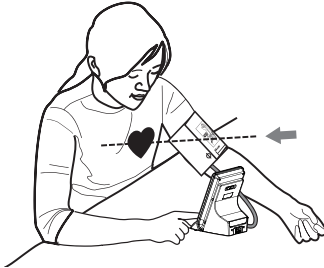

7. This cuff is suitable for your use if the arrow falls within the solid color line. If the arrow falls outside the solid color line, you will need a cuff with other circumferences. Contact your local dealer for additional size cuffs. Using the correct cuff size is important for an accurate reading.

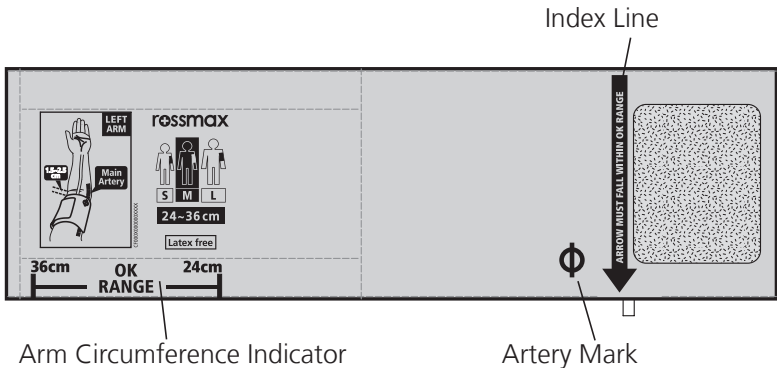

Arm Circumference Indicator

Artery Mark

Measurement Procedures

Here are a few helpful tips to help you obtain more accurate readings:

- Blood pressure changes with every heartbeat and is in constant fluctuation throughout the day.
 - Blood pressure recording can be affected by the position of the user, his or her physiological condition and other factors. For greatest accuracy, wait one hour after exercising, bathing, eating, drinking beverages with alcohol or caffeine, or smoking to measure blood pressure.
 - Before measurement, it's suggested that you sit quietly for at least 5 minutes as measurement taken during a relaxed state will have greater accuracy. You should not be physically tired or exhausted while taking a measurement.
 - Do not take measurements if you are under stress or tension.
 - During measurement, do not talk or move your arm or hand muscles.
 - Take your blood pressure at normal body temperature. If you are feeling cold or hot, wait a while before taking a measurement.
 - If the monitor is stored at very low temperature (near freezing), have it placed at a warm location for at least one hour before using it.
 - Wait 5 minutes before taking the next measurement.
1. Press the ON/OFF key. All digits will light up, checking the display functions. The checking procedure will be completed in 2 seconds.
 2. After all symbols appear, the display will show a blinking "0". The monitor is ready to measure.
 3. **Auto Mode**
 - In Auto mode, **AUTO** mark appears on the display.
 - Press the START key, the monitor will automatically inflate the cuff slowly to start measurement.
 - When the measurement is completed, the cuff will exhaust the pressure inside. Systolic pressure, diastolic pressure and pulse will be shown simultaneously on the LCD screen. The measurement is then automatically stored into memory zone.

This monitor will re-inflate automatically to approximately 220 mmHg if the system detects that your body needs more pressure to measure your blood pressure.

4. Manual Mode

- Switching Auto mode to Manual mode by pressing the **(A⇌M)** key on the back of the unit.
- The default deflation rate is 2.5 mmHg/sec.
- Press the START key, the monitor will automatically inflate the cuff slowly to start measurement.
- While the unit starts deflating, press the Marker key to record the onset of Korotkoff sound as the systolic pressure, and press the Marker key again to record the disappearance of the Korotkoff sound as diastolic pressure.
- When the measurement is completed, the cuff will exhaust the pressure inside. Systolic pressure and diastolic pressure will be showed simultaneously on the LCD screen.

- Note:**
1. This monitor automatically switches off approximately 5 minutes after last key operation.
 2. To interrupt the measurement, simply press the START/STOP and ON/OFF key; the cuff will deflate immediately.
 3. During the measurement, do not talk or move your arm or hand muscles.

Setting Deflation Rate

In the Manual mode, selecting the deflation rate of 2.5 mmHg/sec, 4.5 mmHg/sec, 6.5 mmHg/sec by pressing the **(SET)** key on the back of the unit.

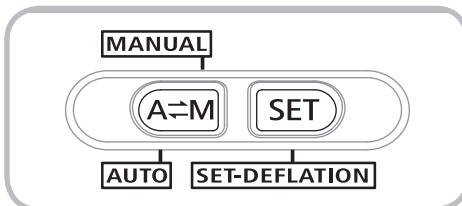

Recalling Values from Memory

1. Press the Memory key to view the last previously stored measurement. Every measurement comes with a assigned memory sequence number.
2. The memory bank can store up to 7 readings under Auto mode. The number of readings exceeds 7, the oldest data will be replaced with the new record.

Clearing Values from Memory

Under Auto mode, press and hold the Memory key for approximately 5 seconds, then the data can be erased automatically.

How to clean the unit after use

Caution:



- When cleaning this unit, please unplug the AC adaptor from the electric outlet. You may suffer electric shock.
- After cleaning this unit, dry it well, then plug the AC adaptor in the electric outlet. You may suffer electric shock.

General advice:

- Do not clean this unit with gasoline, paint thinner, or high concentration alcohol.
 - Do not disinfect this unit by autoclave or gas sterilization (EOG, formaldehyde, or high concentration ozone.)
1. Wipe the blood pressure monitor with a soft cloth squeezed well after moistened with water, diluted disinfectant alcohol, or diluted detergent.
 2. Then wipe the monitor with a soft dry cloth.

Troubleshooting

If any abnormality should arise during use, please check the following points.

Symptoms	Check Points	Correction
No display when the ON/OFF key is pressed	Have the batteries run down?	Replace them with four new batteries.
	Have the batteries' polarities been positioned incorrectly?	Re-insert the batteries in the correct positions.
EE mark shown on display or the blood pressure value is displayed excessively low (high)	Is the cuff placed correctly?	Wrap the cuff properly so that it is positioned correctly.
	Did you talk or move during measurement	Measure again. Keep wrist steady during measurement.
	Did you vigorously shake the cuff during measurement?	

Note: If the unit still does not work, return it to your dealer. Under no circumstance should you disassemble and repair the unit by yourself.

Specifications

Measurement Method :	Oscillometric
Measurement Range :	Pressure: 30~260mmHg; Pulse: 40~199 beats/ minute
Pressure Sensor :	Semi conductor
Accuracy :	Pressure: ± 3 mmHg; Pulse : $\pm 5\%$ of reading
Inflation :	Pump Driven
Deflation :	Automatic Pressure Release Valve
Memory capacity :	7 memories
Auto-shut-off :	5 minute after last key operation
Operation Environment :	10°C~40°C (50°F~104°F); 40%~85% RH; 700~1060 hPa
Storage and Transportation Environment :	-10°C~60°C (14°F~140°F); 10%~90% RH; 700~1060 hPa
DC Power Source :	DC 4.8V 1700mAh NIMH Battery
AC Power Source :	DC 7.5V, ≥ 1.5 A(Plug size: outer(-) is $\varnothing 3.8$, inner(+) is $\varnothing 1.35$)
Dimensions :	130(L) x 133(W) x 167.5(H) mm
Weight :	600 g (G.W.) (w/o Batteries)
Limited users :	Adult users
IP Classification	IP21: Protection against harmful ingress of water and particulate matter
 :	Type BF: Device and cuff are designed to provide special protection against electrical shocks.
*Specifications are subject to change without notice.	



WARNING: The symbol on this product means that it's an electronic product and following the European directive 2012/19/EU the electronic products have to be disposed on your local recycling centre for safe treatment.

EMC guidance and manufacturer's declaration

Guidance and manufacturer's declaration-electromagnetic emissions		
The AC1000f is intended for use in the electromagnetic environment specified below. The customer or the user of the AC1000f should assure that it is used in such an environment.		
Emission test	Compliance	Electromagnetic environment-guidance
RF emissions CISPR 11	Group 1	The AC1000f uses RF energy only for its internal function. Therefore, its RF emissions are very low and are not likely to cause any interference in nearby electronic equipment.
RF emissions CISPR 11	Class B	The AC1000f is suitable for use in all establishments, including domestic establishments and those directly connected to the public low-voltage power supply network that supplies buildings used for domestic purposes.
Harmonic emissions IEC 61000-3-2	Class A	
Voltage fluctuations/flicker emissions IEC 61000-3-3	Compliance	

Guidance and manufacturer's declaration-electromagnetic immunity			
The AC1000f is intended for use in the electromagnetic environment specified below. The customer or the user of the AC1000f should assure that it is used in such an environment.			
Immunity test	IEC 60601 test level	Compliance level	Electromagnetic environment-guidance
Electrostatic discharge (ESD) IEC 61000-4-2	± 6 kV contact ± 8 kV air	± 6 kV contact ± 8 kV air	Floors should be wood, concrete or ceramic tile. If floors are covered with synthetic material, the relative humidity should be at least 30%
Electrical fast transient/burst IEC 61000-4-4	± 2kV for power supply lines ± 1kV for input / output lines	± 2kV for power supply lines Not applicable	Mains power quality should be that of a typical commercial or hospital environment.
Surge IEC 61000-4-5	± 1kV line(s) to line(s) ± 2kV line(s) to earth	± 1kV differential mode Not applicable	Mains power quality should be that of a typical commercial or hospital environment.
Voltage Dips, short interruptions and voltage variations on power supply input lines IEC 61000-4-11	<5% UT(>95% dip in UT) for 0,5 cycle 40% UT(60% dip in UT) for 5 cycles 70% UT(30% dip in UT) for 25 cycles <5% UT(>95% dip in UT) for 5 s	<5% UT(>95% dip in UT) for 0,5 cycle 40% UT(60% dip in UT) for 5 cycles 70% UT(30% dip in UT) for 25 cycles <5% UT(>95% dip in UT) for 5 s	Mains power quality should be that of a typical commercial or hospital environment. If the user of the AC1000f requires continued operation during power mains interruptions, it is recommended that the AC1000f be powered from an uninterruptible power supply or a battery.
Power frequency (50/60 Hz) magnetic field IEC 61000-4-8	3 A/m	3 A/m	Power frequency magnetic fields should be at levels characteristics of a typical location in a typical commercial or hospital environment.
NOTE: UT is the a.c. mains voltage prior to application of the test level.			

Guidance and manufacturer's declaration-electromagnetic immunity			
The AC1000f is intended for use in the electromagnetic environment specified below. The customer or the user of the AC1000f should assure that it is used in such and environment.			
Immunity test	IEC 60601 test level	Compliance level	Electromagnetic environment-guidance
Conducted RF IEC 61000-4-6	3 Vrms 150 KHz to 80 MHz	3 Vrms	Portable and mobile RF communications equipment should be used no closer to any part of the AC1000f including cables, than the recommended separation distance calculated from the equation applicable to the frequency of the transmitter. Recommended separation distance: d = 1,2 √P d = 1,2 √P 80MHz to 800 MHz d = 2,3 √P 800MHz to 2,5 GHz
Radiated RF IEC 61000-4-3	3 V/m 80MHz to 2,5 GHz	3 V/m	

EMC guidance and manufacturer's declaration

		<p>Where P is the maximum output power rating of the transmitter in watts (W) according to the transmitter manufacturer and d is the recommended separation distance in metres (m). Field strengths from fixed RF transmitters, as determined by an electromagnetic site survey, a should be less than the compliance level in each frequency range. b Interference may occur in the vicinity of equipment marked with the following symbol:</p>
--	--	--

NOTE 1: At 80 MHz and 800 MHz, the higher frequency range applies.

NOTE 2: These guidelines may not apply in all situations. Electromagnetic propagation is affected by absorption and reflection from structures, objects and people.

a: Field strengths from fixed transmitters, such as base stations for radio (cellular/cordless) telephones and land mobile radios, amateur radio, AM and FM radio broadcast and TV broadcast cannot be predicted theoretically with accuracy. To assess the electromagnetic environment due to fixed RF transmitters, an electromagnetic site survey should be considered. If the measured field strength in the location in which the AC1000f is used exceeds the applicable RF compliance level above, the AC1000f should be observed to verify normal operation. If abnormal performance is observed, additional measures may be necessary, such as re-orienting or relocating the AC1000f.

b: Over the frequency range 150 kHz to 80 MHz, field strengths should be less than 3 V/m.

Recommended separation distance between portable and mobile RF communications equipment and the AC1000f

The AC1000f is intended for use in an electromagnetic environment in which radiated RF disturbances are controlled. The customer or the user of the AC1000f can help prevent electromagnetic interference by maintaining a minimum distance between portable and mobile RF communications equipment (transmitters) and the AC1000f as recommended below, according to the maximum output power of the communications equipment.

Rated maximum output power of transmitter / W	Separation distance according to frequency of transmitter / m		
	150 kHz to 80 MHz $d = 1,2 \sqrt{P}$	80 MHz to 800 MHz $d = 1,2 \sqrt{P}$	800 MHz to 2,5 GHz $d = 2,3 \sqrt{P}$
0,01	0,12	0,12	0,23
0,1	0,38	0,38	0,73
1	1,2	1,2	2,3
10	3,8	3,8	7,3
100	12	12	23

For transmitters rated at a maximum output power not listed above, the recommended separation distance d in metres (m) can be estimated using the equation applicable to the frequency of the transmitter, where P is the maximum output power rating of the transmitter in watts (W) according to the transmitter manufacturer.

NOTE 1: At 80 MHz and 800 MHz, the separation distance for the higher frequency range applies.

NOTE 2: These guidelines may not apply in all situations. Electromagnetic propagation is affected by absorption and reflection from structures, objects and people.

 Rossmax Swiss GmbH,
 Tramstrasse 16, CH-9442 Berneck,
 Switzerland



ISO CE
 9001/13485 0120

DBM_IB_AC1000f_EN_SW_ver1417
 IN0AC1000f000000XX

www.rossmax.com