

GE Healthcare

## **TONOPORT VI**

Ambulatory Blood Pressure System

Firmware Version 3.0

Operator's Manual

2001589-312 ENG    Revision A



---

**Note**

The information in this manual only applies to TONOPORT VI, firmware version 3.0. It does not apply to earlier firmware versions.

Due to continuing product innovation, specifications in this manual are subject to change without notice.

CASE™ is a trademark owned by GE Medical Systems *Information Technologies* GmbH, a General Electric Company going to market as GE Healthcare.

© 2016 General Electric Company. All rights reserved.



<b>1</b>	<b>Application, Safety Information</b>	<b>6</b>
<b>2</b>	<b>Controls and Indicators</b>	<b>10</b>
<b>3</b>	<b>Setup</b>	<b>12</b>
<b>4</b>	<b>Application</b>	<b>18</b>
<b>5</b>	<b>Data Output</b>	<b>23</b>
<b>6</b>	<b>Error Codes</b>	<b>24</b>
<b>7</b>	<b>Software Installation</b>	<b>25</b>
<b>8</b>	<b>Cleaning, Maintenance, Disposal</b>	<b>27</b>
<b>9</b>	<b>Technical Specifications</b>	<b>29</b>
<b>10</b>	<b>Order Information</b>	<b>30</b>
<b>11</b>	<b>Appendix - Electromagnetic Compatibility (EMC)</b>	<b>31</b>

### **Revision History**

This manual is subject to the GE Healthcare change order service. The revision code, a letter that follows the document part number, changes with every update of the manual.

<b>Part No./Revision</b>	<b>Date</b>	<b>Comment</b>
2001589-312 Revision A	2017-01	Initial Release

## General Information

- The product **TONOPORT VI** bears the CE marking **CE-0482** (notified body MEDCERT GmbH) indicating its compliance with the provisions of the Council Directive 93/42/EEC about medical devices (including amendment 2007/47/EC) and fulfills the essential requirements of Annex I of this directive. It has an internal power source and is an MDD class IIa device. The device fulfills the requirements of the Directive 2011/65/EU of the European Parliament and of the Council.
- It has a type BF applied part.
- The product fulfills the requirements of the standard EN/IEC 60601-1 "Medical Electrical Equipment, Part 1: General Requirements for Basic Safety and Essential Performance" as well as the electromagnetic immunity requirements of the standard EN/IEC 60601-1-2 "Medical electrical equipment – Collateral standard: Electromagnetic compatibility – Requirements and tests" and applicable amendments.
- The product is clinical validated. The validation fulfills the standard ISO 81060-2:2013 "Non-invasive sphygmomanometers - Part 2: Clinical investigation of automated measurement type" and the protocol ESH-IP 2010 from the European Society of Hypertension.
- The radio-interference emitted by this product is within the limits specified in CISPR11/EN 55011, class B.
-  The device is certified by UL and thus also fulfills the UL safety requirements.
- The CE marking covers only the accessories listed in the "Order Information" chapter.
- This manual is an integral part of the equipment. It should be available to the equipment operator at all times. Close observance of the information given in the manual is a prerequisite for proper equipment performance and correct operation and ensures patient and operator safety. **Please note that information pertinent to several chapters is given only once. Therefore, carefully read the manual once in its entirety.**
- The symbol  means: Follow the instructions given in the operator manual. It indicates points which are important to avoid faulty measurements or injuries like strangulation of the arm.

- This manual reflects the equipment specifications and applicable safety standards valid at the time of printing. All rights are reserved for devices, circuits, techniques, software programs, and names appearing in this manual.
- On request GE Healthcare will provide a Field Service Manual.
- The safety information given in this manual is classified as follows:

### Danger

*indicates an imminent hazard. If not avoided, the hazard will result in death or serious injury.*

### Warning

*indicates a hazard. If not avoided, the hazard can result in death or serious injury.*

### Caution

*indicates a potential hazard. If not avoided, the hazard may result in minor injury and/or product/property damage.*

- To ensure patient safety and interference-free operation and to guarantee the specified measuring accuracy, we recommend using only original accessories available through GE Healthcare. The user is responsible for application of accessories from other manufacturers.



PAR Medizintechnik GmbH & Co. KG

Sachsendamm 6

10829 Berlin

Germany

Tel. +49 30 235 07 00

Fax +49 30 213 85 42

**Distributor:**

GE Medical Systems

*Information Technologies, Inc.*

8200 West Tower Avenue

Milwaukee, WI 53223 USA

Tel: +1 414 355 5000

1 800 437 1171 (USA only)

1 800 668 0732 (Canada only)

Fax: +1 414 355 3790

The country of manufacture is indicated on the device label.

# 1 Application, Safety Information

## 1.1 Application

### Intended use

TONOPORT VI is a small-size, portable blood pressure monitor for ambulatory, non-invasive measurement of the patient's blood pressure. If the blood pressure cuffs listed in chapter "Order Information" on page 30 fit the patient, it can be used on adults and pregnant (including pre-eclamptic) women. TONOPORT VI is **not** suitable for blood pressure measurements in neonates. Also, it is **not** suitable for use in intensive-care medicine.

TONOPORT VI is intended for use following consultation and instruction by a physician.

TONOPORT VI can record up to 400 blood pressure measurements at selectable intervals and save the results.

#### Note

*CASE™ or CardioSoft version 6.73 SP2 supports only up to 200 memory readings, CardioSoft version 7.0 or later up to 400 memory readings.*

There is a choice of three different measurement protocols.

#### Using TONOPORT VI with CASE™/CardioSoft

*TONOPORT VI can be operated in conjunction with CASE™ (version 6.73 SP2 or later) or with the analysis program CardioSoft (version 6.73 SP2 or later) that is included with TONOPORT VI. If the USB port is used, it is necessary to install the appropriate driver first (see "Software Installation" on page 24). With these systems, individual measurement protocols can be created and the stored data can be reviewed on screen in tabular and graphic form. The patient ID used by the analysis program can be stored in TONOPORT VI to allow the collected data to be downloaded without selecting the patient first (refer to the respective Operator Manuals; you will find the CardioSoft manual on the CardioSoft DVD).*

#### Biocompatibility

*The parts of the equipment described in this manual, including all accessories, that come in contact with the patient during the intended use, fulfill the biocompatibility requirements of the applicable standards if used as intended. If you have questions in this matter, please contact GE Healthcare or its representative.*

### Oscillometric Measurement Method

The blood pressure is measured by the oscillometric method. The criteria for this method are the pressure pulsations superimposed with every systole on the air pressure in the cuff.

In order to measure the blood pressure, a blood pressure cuff wrapped around the upper arm needs to be inflated and subsequently deflated. The blood pressure is determined either during deflation of the cuff (deflation measurement method) or, by using a novel and faster technology, already during inflation of the cuff (inflation measurement method).

The deflation measurement method is the most common method used. With this technique, the cuff is inflated to a pressure which must be clearly above the expected systolic value. Including cuff inflation, the measurement typically takes approx. 40 seconds.

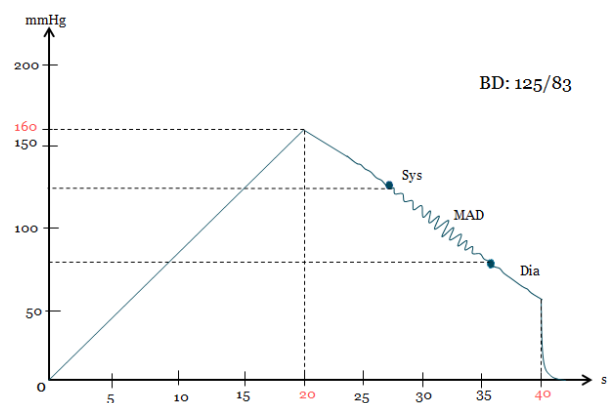

Fig. 1-1 Waveform representing the pressure in the cuff during a measurement using the deflation measurement method: systolic pressure at 125 mmHg, diastolic pressure at 83 mmHg

The inflation measurement method is a novel method based on the "Inflation Measurement Technology (IMT)" developed by PAR Medizintechnik. With this innovative technique, the cuff is inflated to a pressure just above the expected systolic value. Once the systolic value is determined, the cuff can immediately and quickly be deflated. The measurement typically takes only approx. 20 seconds.

If disturbances occur during measurements with the inflation measurement method, which may be due to motion artifacts, for example, TONOPORT VI will automatically switch to the deflation measurement method and complete the blood pressure measurement.

## 1.2 Functional Description

The TONOPORT VI monitor accommodates the blood pressure measuring system and a microprocessor for system control and data processing.

A second microprocessor with a second pressure transducer and a second valve are provided for control of the technical safety.

The monitor is powered by two AA size batteries (either rechargeable NiMH batteries or alkaline batteries).

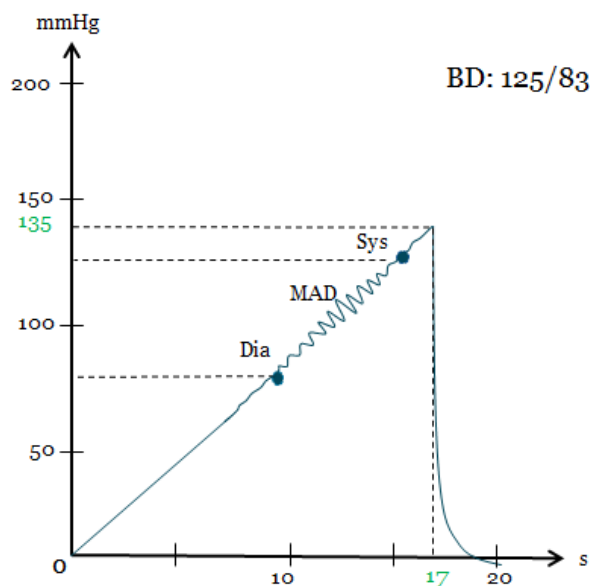

Fig. 1-2 Waveform representing the pressure in the cuff during a measurement using the inflation measurement method: systolic pressure at 125 mmHg, diastolic pressure at 83 mmHg

With both methods, a pressure transducer measures the cuff pressure as well as the superimposed pressure pulsations. During blood pressure measurements the cuff must be at heart level. If this is not ensured, the hydrostatic pressure of the liquid column in the blood vessels will lead to incorrect results.

When the patient is sitting or standing during measurements, the cuff is automatically at the correct level.

## 1.3 Safety Information

### Danger

#### *Risk to Persons—*

- *The equipment is not designed for use in areas where an explosion hazard may occur. Explosion hazards may result from the use of flammable anesthetic mixtures with air or with oxygen, nitrous oxide (N<sub>2</sub>O), skin cleansing agents, or disinfectants.*

### Warning

#### *Risk to Persons—*

- *Equipment may be connected to other equipment or to parts of systems only when it has been made certain that there is no danger to the patient, the operators, or the environment as a result. To ensure such a secure connection the equipment or parts of systems have to comply with the standard IEC 60601-1 or IEC 62368-1.*
- *Connection of this device to an IT-network that includes other equipment could result in previously unidentified risks to patients, operators or third parties. The responsible organization should identify, analyze, evaluate and control these risks.*
- *Changes to the IT-network could introduce new risks that require additional analysis.*  
*Changes to the IT-network include:*
  - *changes in network configuration*
  - *connection of additional items (e.g. connecting another TONOPORT device to another port of the PC can lead to interference during data transfer)*
  - *disconnection of items*
  - *update or upgrade of equipment*
- *TONOPORT VI may be connected to CASE™ or to a PC with the CardioSoft program. While connected to any of these devices, TONOPORT VI must be disconnected from the patient.*
- *Chemicals required, for example, for the maintenance of the equipment must under all circumstances be prepared, stored, and kept at hand in their specific containers. Failure to observe this instruction may have severe consequences.*
- *The equipment has no protection against the ingress of liquids. Liquids must not enter the equipment. Equipment into which liquids have entered must be inspected by a service technician before use.*
- *Before cleaning, TONOPORT VI must be disconnected from other equipment (CASE™, PC).*
- *Dispose of the packaging material, observing the applicable waste-control regulations. Keep the packaging material out of children's reach.*



**Warning**

***Incorrect measurements—***

- ***Magnetic and electrical fields are capable of interfering with the proper performance of the equipment. For this reason make sure that external equipment operated in the vicinity of TONOPORT VI complies with the relevant EMC requirements. X-ray equipment, MRI devices, radio systems etc. are possible sources of interference as they may emit higher levels of electromagnetic radiation.***

**Caution**

***Equipment damage, risk to persons—***

- ***Before connecting the battery charger to the power line, check that the voltage ratings on the nameplate match those of your local power line.***
- ***The battery charger is not a medical device. Its use in the patient environment is not permitted.***
- ***Before using the equipment, the operator must ascertain that it is in correct working order and operating condition.***
- ***The operator must be trained in the use of the equipment.***
- ***Only persons who are trained in the use of medical technical equipment and are capable of applying it properly are authorized to apply such equipment.***
- ***There are no user-replaceable components inside the equipment. Do not open the housing. For service or repair, please contact your local, authorized dealer (<http://gehealthcare.com>).***

## 2 Controls and Indicators

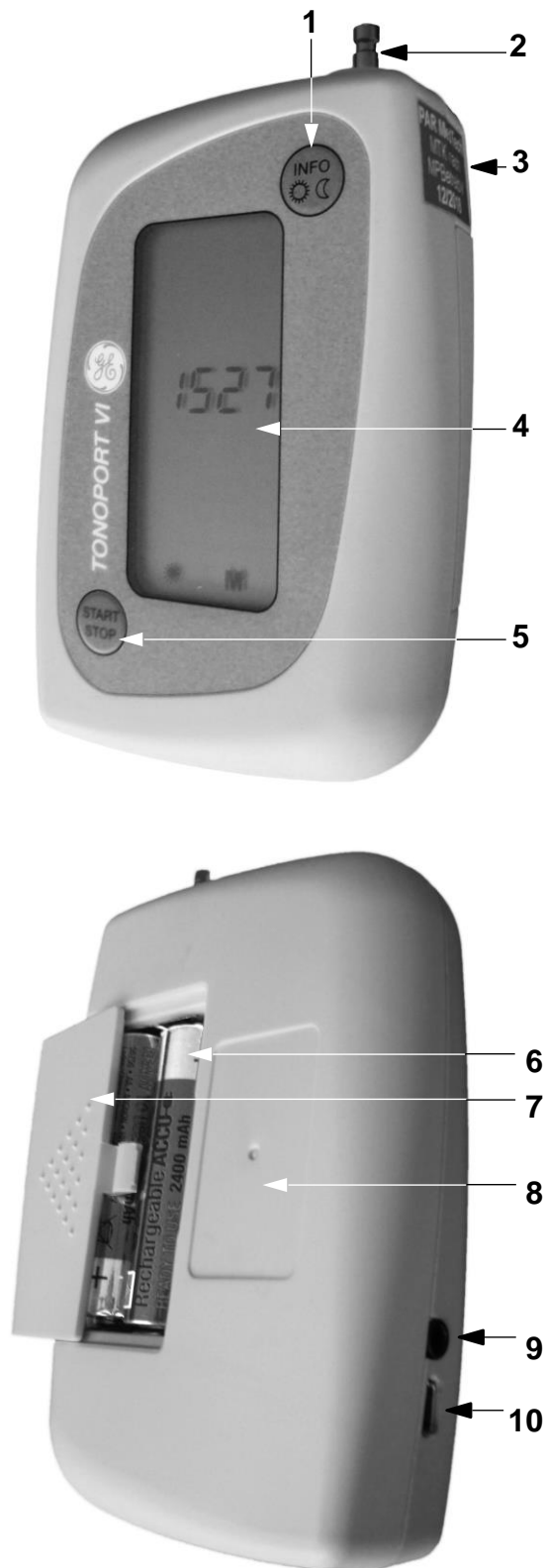



Fig. 2-1 Controls and indicators of TONOPORT VI

### Functions of Button















Button	Message on display	Function
Push once	H 1	clear memory
Push twice	H 2	set date and time
Push 3 times	H 3	select measurement protocol
Push 4 times	H 4	activate calibration mode
Push 5 times	H 5	display firmware version
Push 6 times	H 6	select energy source
Push 7 times	H 7	enable/disable audio signal
Push 8 times	H 8	toggle pressure unit between mmHg and kPa
Push 9 times	H 9	select measurement method: deflation measurement method or inflation measurement method

- 1 Button : push to display the most recent parameter readings. The display will show:
  - systolic value "S" (unit mmHg or kPa shown on the display)
  - diastolic value "D" (unit mmHg or kPa shown on the display)
  - pulse rate "HR" (unit  $\text{min}^{-1}$ )
 The same button is used
  - to toggle between the day phase and the night phase (section "Toggling Between Day and Night Phase" on page 22) and
  - to program the BP monitor (chapter 3 "Setup" on page 12)
- 2 Connection for blood pressure cuff
- 3 Calibration mark
- 4 Liquid crystal display (LCD)
- 5 Button : push to start and stop a measurement and to confirm entries
- 6 (Rechargeable) batteries
- 7 Lid covering battery compartment
- 8 Nameplate
- 9 Port for connection to PC (RS232)
- 10 Port for connection to PC (USB)

## Explanation of Signs and Symbols

### Symbols used on the equipment and on the packaging

	Follow the instructions given in the operator manual.
	This symbol indicates that the waste of electrical and electronic equipment must not be disposed as unsorted municipal waste and must be collected separately. Please contact an authorized representative of the manufacturer for information concerning the decommissioning if your equipment.
	Type BF applied part (defibrillation-proof, recovery time $t_R < 1s$ )
	Catalogue number
	Serial number
	CE marking
	CE marked per the Council Directive 93/42/EEC of the European Union. Notified body: MEDCERT GmbH
	Gossudarstwenny Standard Russia (GOST)
	UL-certified product
<b>Rx Only</b>	US Federal law restricts this device to sale by or on the order of a physician.
<b>IP20</b>	Protection against ingress of solid foreign objects and no protection against ingress of water.
<b>IP02</b>	No protection against contact and ingress of objects and protection against dripping water when tilted at 15°
	Keep dry
	USB port, connection to PC
	Serial port, connection to PC



Manufacturer's identification



Date of manufacture.  
The number found under this symbol is the date of manufacture in the YYYY-MM format.



Calibration mark, valid in Germany only (see "Technical Inspection of the Measuring System" on page 29)

### Symbols used on the display



Blinks with each detected oscillation; is continuously displayed when the monitor contains data.



Blinks when the batteries are almost depleted; is continuously displayed when batteries are discharged and no more BP measurement can be taken.



Day phase selected



Night phase selected

### Further relevant symbols used on the battery charger



Polarity of the DC input (charger only)



Approval mark for use of the equipment in a vehicle (charger only, xxx-xx xxxx alphanumeric characters)



Protection class II equipment



For indoor use only



Approval mark for Japan



Pollution control symbol according to the Chinese standard SJ/T11363-2006



Restriction of certain hazardous substances.  
The device fulfills the requirements of the Directive 2011/65/EU of the European Parliament and of the Council.

### 3 Setup

#### Some Basic Facts on Battery Power

TONOPOINT VI is either powered by two rechargeable nickel-metal hydride batteries (NiMH) or by two alkaline batteries. The device must be set to the power source used (see section "Inserting Batteries" on page 12). The device also contains a Lithium cell that powers the clock. The Lithium cell can only be replaced by a service technician.

The capacity of two fully charged or new batteries is sufficient for up to 400 blood pressure measurements.

The capacity of rechargeable batteries decreases with age. If the capacity of fully charged batteries is considerably less than 24 hours, the batteries must be replaced.

#### Caution

##### Equipment Damage—

- Only use the original rechargeable, size AA nickel-metal hydride batteries (from manufacturers such as Sanyo, Panasonic, Energizer, Duracell, Varta, GP) with a capacity  $\geq 1500$  mAh or high-rate discharge, size AA alkaline batteries (such as Panasonic Evoia, Energizer Ultimate, Duracell Ultra, Duracell Power Pix, Varta maxtech).
- Charge the NiMH batteries to capacity before using them for the first time.
- Recharge the NiMH batteries immediately after use and do not leave batteries uncharged.
- Use only the original charger to recharge the NiMH batteries.
- Do not attempt to recharge alkaline batteries.
- If TONOPOINT VI will not be used for one month or more, remove the (rechargeable) batteries from the device.
- Batteries must not be disposed as unsorted municipal waste and must be collected separately. Please contact an authorized representative of the manufacturer for information concerning the decommissioning of the batteries.

#### Inserting Batteries







- Open the battery compartment on the back of TONOPOINT VI as shown in Fig. 3-1.



Fig. 3-1 Opening the battery compartment

- Place the two batteries in the compartment as indicated by the symbols.

#### Selecting the Energy Source

- Turn on the BP monitor as follows:
  - either by inserting the batteries or by briefly pressing the  button.
- Wait for the time to be displayed.
- Push  six times: The display shows "H 6".
- Push : the display shows "AAAA" when the BP monitor is set up for rechargeable NiMH batteries (as shipped) and "bbbb" when it is set up for alkaline batteries.
- Confirm the displayed information with  or change the selection with  and confirm the new selection with .
- Next, the BP monitor will briefly display the capacity of the inserted batteries. "A 100", for instance, means that the rechargeable batteries have a capacity of 100%, i.e., they are fully charged, "b 50" means that the alkaline batteries have a capacity of only 50%, i.e., they are half depleted.
- Place the lid on the battery compartment and close.

## Charging NiMH Batteries

### Note

*The energy source needs to be selected only when the BP monitor is put into service for the first time or when you change from NiMH to alkaline batteries and vice versa.*

### Caution

*Equipment damage, patient hazard —*

- *The battery charger is not a medical device. Its use in the patient environment is not permitted.*
- *The contact surface of the NiMH batteries and of the charger must always be kept clean.*
- *The charger is to be used indoors only and must be protected against oil, grease, aggressive detergents and solvents to prevent damage.*
- *If the charger is damaged in any way, e.g., after a drop or when the mains pins are bent, the local authorized dealer must be contacted immediately.*
- *High temperatures affect the charging process. Ideally, the room temperature should not exceed 40°C.*
- *After quick charging, please wait for some minutes before another quick charge. Otherwise the temperature sensors will not function correctly.*

If TONOPORT VI is powered by rechargeable batteries (4 of them are shipped with the equipment), they should be recharged immediately after use (24 hours). Use only the original charger supplied. It consists of an AC power adapter and the charging unit itself.

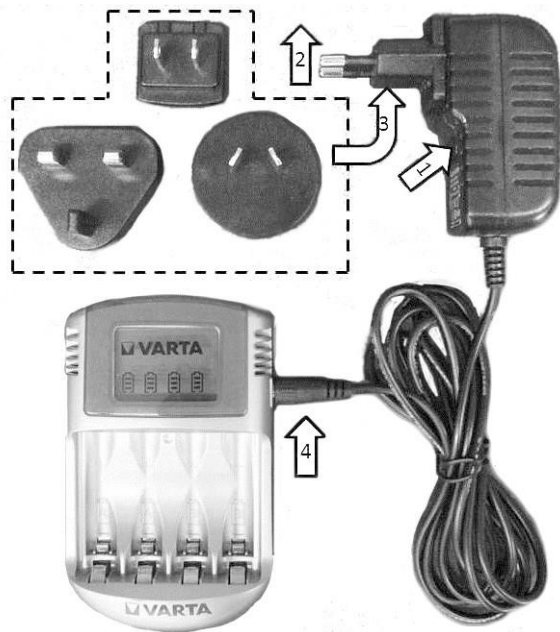

Fig. 3-2 Exchanging the connector, connecting the charging unit

- Check that the voltage ratings on the nameplate of the charging unit match those of your local power line.
- If necessary, replace the connector to match the wall outlet type:
  - push the button below the connector and hold it depressed (1, Fig. 3-2)
  - remove the connector and insert the suitable type of connector 2, 3
  - ensure that the new connector locks into place.
- Connect the cable of the AC power adapter to the charging unit 4 and plug the AC power adapter into the wall outlet.
- Insert the two rechargeable batteries into the charging unit, observing the correct polarity.

### Charging Batteries with the VARTA Charging Unit



Fig. 3-3 Battery symbols and bars in the charging unit display

Insert 4 or 2 batteries. To charge only 2 batteries, insert them in the two compartments on the right or on the left. The batteries take up to 3 hours to recharge. Once the batteries are inserted, battery symbols will appear in the charging unit display where each symbol corresponds to one of the charger compartments (Fig. 3-3). During the charge cycle, the corresponding bar in the battery symbols blinks. Note: If the battery symbols and bar do not light up, only one battery may be inserted or the batteries are inserted the wrong way round. When the batteries are charged, the bars are permanently illuminated. The charging unit now trickle-charges the batteries to compensate for self-discharging.

The battery temperature is monitored in the charger. When the temperature is too high, the bar in the battery symbol is permanently illuminated and the charger switches to trickle-charging.

If the batteries are correctly inserted and the displayed battery symbols show no bars, the charger has identified a battery problem. The charging current will be cut off. Remove the batteries and discard, observing the applicable waste disposal regulations.

## Switching TONOPORT VI ON and OFF

The TONOPORT VI monitor has no power switch. Switch the device on and off as follows:

To switch ON: Insert charged batteries OR briefly press .

To switch OFF: Press  for 3 seconds.



## Performance Check

When turned on, TONOPORT VI runs a self-test that includes all symbols and segments on the LCD (Fig. 3-4). Then it checks the batteries and indicates the remaining capacity. "A 100", for instance, means that the rechargeable batteries have a capacity of 100%, i.e., they are fully charged. "b 50" means that the alkaline batteries have a capacity of only 50%, i.e., they are half depleted.

The minimum battery capacity for a 24-hour measurement is 90%.

If the capacity is below 90%, new or fully charged batteries must be inserted.

BP monitors that have passed the self-test and completed the battery test will indicate the following information:

- the time of day
- the measuring phase (day  / night ), and
- whether data are stored in the BP monitor (**M**) (Fig. 3-5).

The BP monitor will also emit an audio signal if enabled.

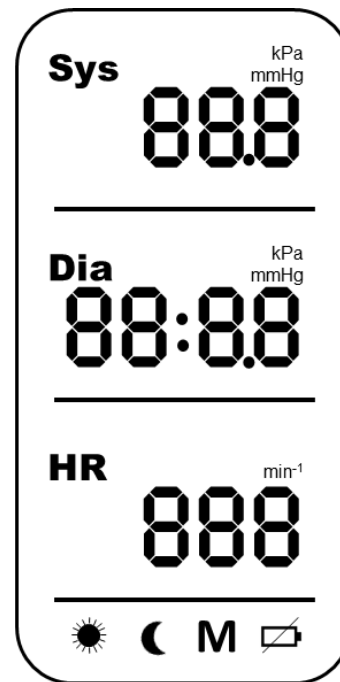

Fig. 3-4 Test display on LCD

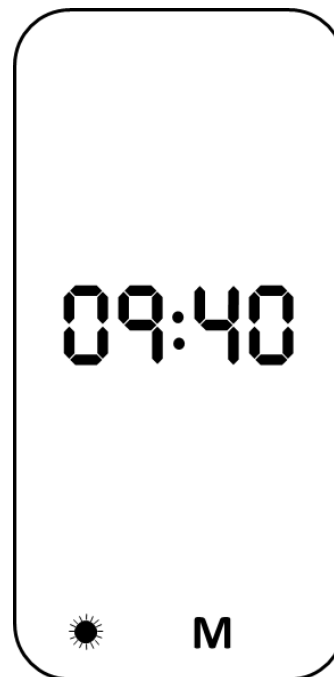



Fig. 3-5 Example: display after successful self-test (**M**= BP data in memory,  measuring phase: day)

Before using TONOPORT VI on a patient





1. clear the memory
2. check date and time and adjust if required
3. select a measurement protocol
4. enable or disable the audio signal.

#### Note





*When using TONOPORT VI in conjunction with CASE™/CardioSoft, it is recommended to perform the first three steps at the PC.*

## Clearing the Memory

The symbol **M** on the display indicates that the memory holds BP data. If these data still need to be analyzed, refer to chapter 5 "Data Output" on page 23 for details on data evaluation. If you do not need the data any more, delete it as follows:

- Briefly switch TONOPORT VI off and on again and wait for the time to be displayed.
- Push : the display indicates "H 1".
- Push : the display indicates "LLLL".
- To delete the data, push  again: the display indicates "0000", followed by the time (if you do not wish to clear the memory, turn off the BP monitor instead of pushing ).

## Selecting the Measurement Method









- Briefly switch TONOPORT VI off and on again and wait for the time to be displayed.
- Push  9 times: the display indicates "H 9".
- Push : the display indicates "0000" if the selected method is the deflation measurement method, or "1111" if the selected method is the inflation measurement method.
- Either confirm with  or switch to the other option with , then confirm with .







## Time and Date

Usually the BP monitors are set to the correct time and date before delivery. Therefore, the time only needs to be corrected to change between Standard Time and Daylight Saving Time.

### Setting Time and Date

- Briefly switch TONOPORT VI off and on again and wait for the time to be displayed.
- Push  twice: the display indicates "H 2".
- Push : The year will be displayed, e.g. "2016".
- If the indicated year is correct, confirm it with  or correct it with , then confirm with .
- The month will be displayed, e.g. "03".
- If the indicated month is correct, confirm it with  or correct it with , then confirm with .
- In the same manner, correct day, hour, and minute.
- In the end, the time of day will be displayed again.

### Selecting the Pressure Unit

- Briefly switch TONOPORT VI off and on again and wait for the time to be displayed.
- Push  8 times: the display indicates "H 8".
- Push : the display indicates "mmHg" or "kPa".
- Either confirm with  or switch to the other option with , then confirm with .





## Measurement Protocols

There is a choice of three different measurement protocols:





Protocol	Day Phase (7 a.m. to 10 p.m.)	Night Phase (10 p.m. to 7 a.m.)
P1	every 15 minutes	every 30 minutes
P2	every 20 minutes	every 40 minutes
P3	every 30 minutes	every 60 minutes

Max. inflation pressure: day phase 250 mmHg  
night phase 220 mmHg

### Selecting a Measurement Protocol

- Briefly switch TONOPORT VI off and on again and wait for the time to be displayed.
- Push  3 times: the display indicates "H 3".
- Push : the display indicates "LLLL" (Selecting a protocol automatically clears the memory. If you want to retain the data, switch the BP monitor off.)
- Push : the display indicates "P1" (protocol 1).
- Either select program 2 or 3 by pushing  or
- confirm the selected protocol with .

### Enabling or Disabling the Audio Signal

- Briefly switch TONOPORT VI off and on again and wait for the time to be displayed.
- Push  7 times: the display indicates "H 7".
- Push : the display indicates "0000" when the audio signal is disabled, and "1111" when it is enabled.
- Either confirm with  or switch to the other option with , then confirm with .

## 4 Application

### Symbols used on the cuff



Follow the instructions given in the operator manual.

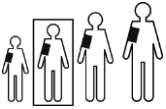

Blood pressure cuff fits adult patient of the size marked by the frame (medium, small, large, or extra large adults).



Blood pressure cuff is suitable for the indicated arm circumference.

**Patient**

When the blood pressure cuff is applied, this label must face the skin.



When the blood pressure cuff is applied, these two arrows must be located over the brachial or femoral artery.



This line identifies the end of the cuff which must be situated within the range identified by the INDEX label when the cuff is closed.

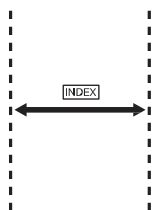

The end of the cuff must be situated within this range when the cuff is closed.



Latex-free blood pressure cuff.



CE marking, cuff fulfills EU directives.

### Cleaning the Cuffs

- Use a moist cloth to wipe the cuffs clean if they are only slightly soiled.
- Clean cuffs that are heavily contaminated by washing them with soapy water or a suitable cleaning agent that contains a disinfectant (do not machine-wash). Ensure that no liquid penetrates into the cuff bladder or the pressure tubing.
- After cleaning, rinse the cuff thoroughly with water and let it dry at room temperature for about 15 hours.
- The cuffs can be disinfected with isopropyl alcohol 70%, ethanol 70%, Microzid, Buraton liquid, Sporicidin, or Cidex. After disinfection, rinse the cuff thoroughly with tap water and air-dry.

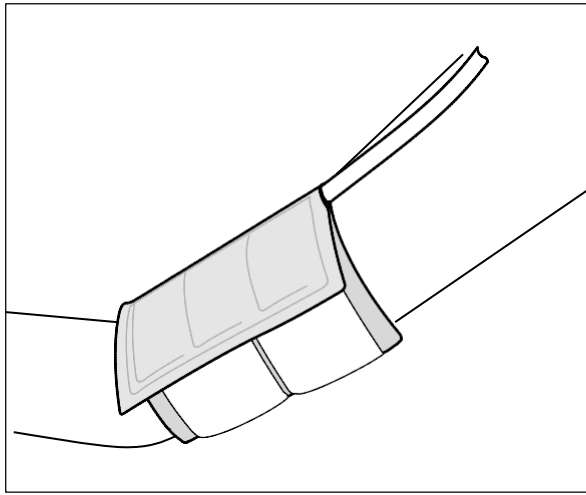

Fig. 4-1 Applying the cuff

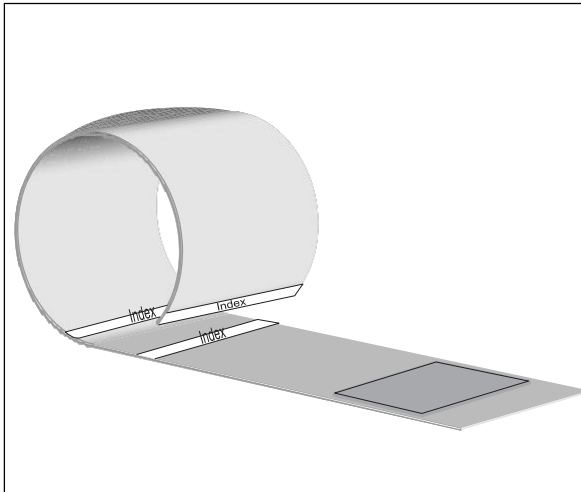

Fig. 4-2 Applying the cuff

## Applying the Cuff

### Warning

**Risk to Persons—**  
**Disconnect TONOPORT VI from other equipment (CASE™, PC) before connecting it to the patient.**

- Always insert two fully charged NiMH batteries or two new alkaline batteries, before starting a measurement.
- Check that the memory has been cleared (see "Clearing the Memory" on page 16).
- Select the appropriate cuff size (see cuff label). **When the cuff is too small the BP values will be overrated, when it is too big, the measured values will be too low.**

### Caution

**Incorrect measurements—**

- Use only the cuffs listed in chapter "Order Information" on page 30.
- Replace cuffs on a regular basis. Damaged Velcro fasteners may cause incorrect readings.



- Place the cuff on that arm of the patient which is used less frequently during normal daily activities: on adults about 2 fingers' breadth above the bend of the elbow. Bending the arm must not change the cuff level. Verify that
  - the cuff tubing points up toward the shoulder (Fig. 4-1)
  - no compression or restriction of connection tubing can occur
  - the side with the Patient label is on the skin
  - the arrow is located above the brachial or femoral artery
  - the dashed white line at the end of the cuff is located between the two dashed Index lines when you close the cuff (if this is not the case, select another cuff size, Fig. 4-2)
  - the cuff fits snugly around the arm, but does not compress the blood vessels.
  - the cuff and the TONOPORT VI is used inside the ambient conditions for operation and inside the measuring range (s. chapter "Technical Specifications").

**Warning**

***Risk to Persons—***

- The effect of blood flow interference can result in a harmful injury to the patient caused by continuous cuff pressure due to connection tubing kinking.*
- Too frequent measurements can cause injury to the patient due to blood flow interference.*
- The application of the cuff over a wound can cause further injury.*
- The application of the cuff and its pressurization on the arm on the side of a mastectomy is not recommended.*
- The pressurization of the cuff can temporarily cause loss of function of simultaneously used monitoring equipment on the same limb.*
- By watching the limb it is necessary to check that operation of the TONOPORT VI does not result in prolonged impairment of patient blood circulation.*

## Performing a Trial Measurement

- Turn on TONOPORT VI and place it in the wearable pouch. There is an aperture in the pouch to accommodate the cuff connection tube.
- Attach the pouch to the patient (shoulder strap, belt). For reasons of hygiene, it is not advised to carry the pouch on the bare skin.
- Guide the pressure tubing around the patient's neck as a strain relief and connect it to the blood pressure cuff port of TONOPORT VI (2, Fig. 2-1). Do not wrap the pressure tubing completely around the neck to avoid strangulation of the patient. You must hear the connector click into place. Ensure that the tube is not kinked or blocked during the measurement.
- Check that the display indicates the time of day. (If the memory contains data from a previous procedure, the letter "M" will appear on the display when you turn on the device. If you still try to initiate a measurement, the message "LLLL" prompts you to clear the memory. Push  twice to delete the data. If you want to retain the data, turn off the device instead of pushing .)
- **To avoid erroneous measurements, ensure that the patient does not move during the trial measurement. The patient may stand or sit.**

- Push  to initiate the first measurement.

Within a few seconds, the device starts inflating the cuff. When the inflation pressure has been reached, the cuff will gradually be deflated (deflation measurement method) or the will be released quickly (inflation measurement method). The changing cuff pressure is indicated on the display and the letter "M" appears with each detected oscillation. At the end of the measurement, the measured data will be displayed



- the systolic readings (S in mmHg or kPa)
- the diastolic readings (D in mmHg or kPa)
- the pulse rate (HR/min<sup>-1</sup>)

If an error code, such as "E 29" (insufficient number of oscillations detected) is displayed after the measurement, tighten the cuff a little and push  again (see also chapter "Error Codes" on page 24).

If the trial measurement has been successfully completed, the device is ready for automatic measurements.

## Patient Information



Advise your patient

- **not to move while a measurement is being taken to avoid motion artifacts that may lead to erroneous readings and to keep the cuff inflation time as short as possible**
- to place TONOPORT VI with the wearable pouch on the night stand while in bed
- how to switch the device manually from the day to the night phase (see page 22)
- that events considered important should be noted down in a diary and that intermediate measurements can be initiated with 
- that the measurement can be stopped at any time with  (the cuff will be deflated)
- not to open the battery compartment or the device
- to protect the device against water, excessive humidity and not to remove the device from the wearable pouch
- about the audio signal and its meaning
- that the pressure tubing may only be removed in emergency situations (see warning below)
- that the cleaning is performed by professional medical personnel and not by the patient

### Warning

**Risk to Persons—**

**Instruct your patient**

- **to terminate the measurement with , whenever the cuff is not deflated within about 2 minutes,**
- **to remove the cuff if it is not deflated after activation of the  button. This could be due to kinked tubing. The cuff must be reapplied as described earlier before additional measurements can be taken.**

### Note

**The operator's manual is restricted to professional healthcare personnel. Do not deliver this document to the patient. Please give the patient a copy of the patient instruction (see page 39).**

**Absolute contraindications:**

The Application of the cuff is prohibit on an arm with

- Dialysis shunt
- Fresh operation wounds
- Masektomy

**Relative Contraindications:**

If the doctor ascertains a positive benefit-risk ratio, the Application of the cuff is allowed on the arm with:

- Lymphedema
- Paresis or plegie
- Arterial or venous vascular access

Other diagnostic or therapeutic measures do not negatively affect the blood pressure measurement.

**Note**

*The professional healthcare personnel have to give some information about the accuracy of the TONOPORT VI to the patient.*

## General Information on Ambulatory BP Measurement

These are the buttons on TONOPORT VI used during an ambulatory blood pressure measurement:



starts and stops a measurement



displays the most recent measurement results or the most recent error message, toggles between day and night phase (see next section)

### Deflation measurement method:

For the first measurement, the cuff is inflated to a pressure of 160 mmHg (initial pressure). For subsequent measurements, the device inflates the cuff to a pressure which is 15 mmHg above the systolic value of the previous measurement (minimum inflation pressure: 120 mmHg).

If the measured value is above the inflation pressure, the device will increase the cuff pressure another 50 mmHg.

### Inflation measurement method:

For each measurement, the device inflates the cuff to a pressure just above the expected systolic pressure.

A manual measurement can be taken at any time between the automatic measurements. Manual measurements are marked in the tabular BP data in CardioSoft.

If unsuccessful, the device will repeat a measurement after 2 minutes. An error code referring to failed measurements is generated in CardioSoft only after three consecutive unsuccessful measurements.

Error codes E02 (battery depleted), E06 (inflation time over) and E08 (400 blood pressure measurements taken) do not lead to a second measurement. The next measurement after error code E06 occurs at the selected interval.

After error codes E02 and E08, the device enters the power-save mode to prevent over-discharging of the rechargeable batteries. This mode can only be terminated by turning the device off and on again.

## Toggling Between Day and Night Phase

In the three measurement protocols, the day phase lasts from 7 a.m. to 10 p.m. and the night phase from 10 p.m. to 7 a.m. On the display, the two phases are represented by the symbols ☀ (day) and ☾ (night).

Patients whose day and night phases are different from these predefined periods can push the  button twice to change from one phase to the other.

### Note

*If the measurement protocol was created with CASE™/CardioSoft and only 1 BP period has been specified, switching from one phase to the other will leave the measurement intervals unchanged. They will always be the same. The information "day phase" and "night phase" is only used to identify the measurements.*

## Audio Signal

If enabled (see page 17), the audio signal will be emitted in the following situations:

- shortly after TONOPORT VI was switched on
- just before TONOPORT VI starts inflating the cuff (during the day phase only)
- after TONOPORT VI has detected an erroneous measurement

## 5 Data Output

The measurement data are output via CASE™/ CardioSoft.

### Warning

**Risk to Persons—**  
**Disconnect TONOPORT VI from other equipment (CASE™, PC) before connecting it to the patient.**

### Note

**If the USB port is used (CardioSoft only), it is necessary to first install the appropriate driver (see "Software Installation" on page 25).**  
**CASE™ must always be connected to the serial port.**

- Put the PC-based system into operation (see Operator Manual of CASE™, CardioSoft).
- Turn off TONOPORT VI.
- Connect TONOPORT VI to the PC system:
  - via cable 2001589-040 if the USB port of TONOPORT VI is used (**b**, Fig. 5-1)
  - via cable 2001589-011 if the serial port of TONOPORT VI is used (**a**, Fig. 5-1)
- Turn on TONOPORT VI and wait for the time to be displayed.

For more information about data output, please refer to the Operator Manual of CASE™, CardioSoft.

When you have finished downloading data to CASE™/ CardioSoft and do not intend to continue working with this system, disconnect TONOPORT VI and turn it off.

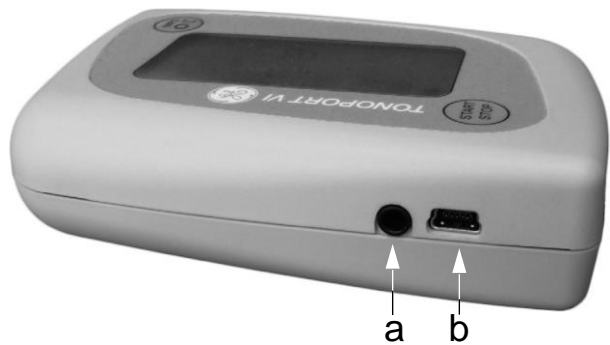

Fig. 5-1 Connections for PC cable

- a RS232 port
- b USB port



## 6 Error Codes

- E 02** Batteries depleted. Code appears when the battery capacity is insufficient for new BP measurements. The device differentiates between two states: the memory has just been cleared (i.e., the battery test is performed with a higher drain to ensure that fresh batteries will be inserted at the beginning of the measurement) or measurements have already been taken.
- E 03** Measurement time over. Code is displayed after measurement duration of 180 seconds.
- E 06** Inflation time over. The maximum inflation time of 130 seconds has elapsed. This condition indicates a leak in the cuff or tubing, or a defect at the cuff connector.
- E 07** This code appears
- when the device could not determine a systolic value although the cuff pressure was already increased twice
  - when the current cuff pressure would exceed the selected maximum pressure.
- E 08** 400 pressure measurements taken; storage capacity exhausted.
- E 14** Diastolic reading below 40 mmHg. Code appears when the cuff pressure has dropped to 40 mmHg and no diastolic pressure could be identified (TONOPORT VI does not measure diastolic pressures below 40 mmHg).
- E 15** Motion artifact during diastole detection.
- E 17** Internal hardware error. Please contact your local authorized dealer (<http://gehealthcare.com>).
- E 18** Systolic reading outside measuring range.
- E 19** Diastolic reading outside measuring range. (Codes **E 18** and **E 19** are displayed when the systolic and diastolic values are outside the range in which oscillations were detected.)
- E 21** Difference between systolic and diastolic pressure too small (10 mmHg or less).
- E 22** Motion artifact during systole detection.
- E 26** Systolic reading below measuring range.
- E 27** Systolic reading above measuring range.
- E 29** Insufficient number of oscillations detected: For a correct measurement, the system must detect a minimum of 8 oscillations.

**For deflation measurement method:**

Tighten the cuff so that one finger, but not two, can be inserted between the patient's arm and the cuff. At the same time the device switches to a deflation rate of 4 mmHg/s. When it detects more than 13 oscillations later on, the rate changes to 6 mmHg/s.

**For inflation measurement method:**

This error message will not be displayed because TONOPORT VI automatically switches to the deflation measurement method if the number of detected oscillations is insufficient.

## 7 Software Installation

Install CardioSoft and the USB driver on your PC only if you are familiar with the Windows operating system.

**CardioSoft from version 6.73 SP2** and the USB driver run only under these operating systems: Windows 8.1 Pro and Enterprise 64-bit, as well as Windows 7 Professional 32-bit, 64-bit.

### CardioSoft (Standalone Workstation)

You will need administrator privileges for installation.

1. Turn on the PC and the monitor. Exit ALL programs.
2. Insert the CardioSoft DVD in the DVD ROM drive. If the DVD drive does not automatically start up, start "setup.exe" (on the CardioSoft DVD in folder "CASE-CS") via Windows Explorer.
3. Follow the displayed prompts.
4. Confirm the two proposed directories with *Next*.
5. Enter the serial number (see DVD-ROM).  
CardioSoft will now be installed on your computer.
6. Restart Windows.

#### Note

*If you will be using the serial port of TONOPORT VI (a, Fig. 5-1), installation is now complete.*

*To be able to use the USB port of TONOPORT VI (b, Fig. 5-1), you need to install the USB driver and check the communication as described below.*

### USB Driver

You will need administrator privileges for installation.

1. Turn on the PC and the monitor. Exit ALL programs.
2. Insert the CD with the USB drivers in the CD ROM drive. If the CD drive does not automatically start up, start "setup.exe" (on the USB driver CD in folder "Disk1") via Windows Explorer.
3. Follow the displayed prompts.  
Select *Allow* if the system informs you that you are using an unidentified program.
4. Click *Finish* to complete the first part of the USB driver installation procedure.
5. Turn on TONOPORT VI and connect it to the PC, using the USB connection cable. Windows will automatically detect TONOPORT VI (TUSB3410 device).
6. Follow any additional prompts that may be displayed.
7. When Windows indicates that the drivers were successfully installed and the new hardware can be used, remove the USB driver CD from the CD-ROM drive.

## Checking the Port

**USB port** check only:

For a check of the USB port, turn on TONOPORT VI and connect its USB port to the PC.

1. Start the Device Manager of the operating system.
2. Double-click *Ports (COM and LPT)* to view all ports.

**If CardioSoft version 6.72 or higher is used or if a USB serial port/TUSB3410 Device between COM1 and COM4 has been selected**, it is not necessary to choose another port. Note down the selection because the same port must be set in CardioSoft, and close all windows to return to the Windows desktop.

**If a USB serial port greater than COM4 has been selected**, one of the ports COM1 through COM4 must be disabled at the PC so that it can be assigned to the USB port.

3. Select one of the ports COM1 through COM4 that is not needed for other devices and disable it (right-click > *Disable*). Confirm the message that the device will not be functional any longer.
4. When using the **USB port**:  
Right-click *USB - Serial Port (COM X)* and click *Properties*.
5. Click *Port Settings > Advanced*, and at *COM Port Number*, select the port that you disabled earlier. Select *Yes* if a message appears that this COM port is already used by another device. The selected port must be also be set in CardioSoft.
6. Select *OK* where needed and/or close all windows to save the settings.
7. Disconnect the USB cable and restart Windows.

## 8 Cleaning, Maintenance, Disposal

### 8.1 Cleaning, Disinfection

#### Equipment Surface

##### Warning

**Shock Hazard—**  
*Disconnect TONOPORT VI from the PC or printer before cleaning.*

- Turn off TONOPORT VI.
- Wipe the device down with a soft, lint-free cloth, using a mild cleaning solution or dish liquid in a low concentration. Many cleaning agents and disinfectants commonly used in hospitals are suitable. Do not let liquid enter the device.

##### Caution

**Equipment Damage—**  
*Do not disinfect the device surface with phenol-based disinfectants or peroxide compounds.*

##### Warning

**Shock hazard, equipment damage —**  
*Equipment into which liquids have entered must be inspected by a service technician before use.*

##### Warning

**Equipment and accessory have to be disinfected between the uses on different patients. Additionally national regulations for the cleaning and disinfection have to be considered.**

#### Cuffs

Notes regarding the cleaning of blood pressure cuffs: see "Cleaning the Cuffs" on page 18.

#### Cables

- Disconnect cables from the device before cleaning.
- Use a cloth moistened with soapy water to wipe the cables clean. Do not immerse cables in liquid.

### 8.2 Maintenance

#### Checks before each use

- Before each use, visually check the device and the cables for signs of mechanical damage.

If you detect damage or impaired functions which may result in a hazard to the patient or the operator, the device must be repaired before it can be used again.

#### Technical Safety Inspections

For safety, the device requires regular maintenance. To ensure functional and operational safety of TONOPORT VI, Technical Safety Inspections should be carried out on an annual basis.

##### Caution

*These checks shall be carried out by GE Healthcare or authorized companies.*

The checks are carried out within the framework of a service agreement; please contact GE Healthcare Service for details.

The device does not require any other maintenance.

## Technical Inspections of the Measuring System

The non-invasive pressure measurement system of TONOPORT VI should be inspected every two years.

### Caution

*These checks shall be carried out by GE Healthcare or authorized companies.*

The checks are carried out within the framework of a service agreement; please contact GE Healthcare Service for details.

## Disposal of the Product







The product described in this operator manual must not be disposed as unsorted municipal waste and must be collected separately. Please contact an authorized representative of the manufacturer for information concerning the decommissioning of your equipment.

### Warning



*Additionally national regulations for the disposal of potential biologically contaminated material have to be considered.*

## Calibration Mode

(e.g., to check the pneumatic system for leaks)

- Connect a rubber bulb between pressure tubing and cuff, using a T-adapter.
- Roll up cuff tight.
- Turn device off and on again after a few seconds, then wait for time to be displayed.
- Push  four times: the display indicates "H 4".
- Push  : the display indicates an internal value that must be between 25 and 100. If the displayed value is outside this range, TONOPORT VI must be returned for repair.
- Push  again: the display indicates "0" (the display now indicates the pressure in mmHg).
- Generate a test pressure of 200 mmHg and measure the pressure decrease after waiting at least 30 seconds. (Pressure decreases between 3 and 5 mmHg are typical; a pressure decrease > 6 mmHg indicates a leak and the system needs to be repaired.)
- Push  to exit the calibration mode.

## Viewing the Firmware Version

- Turn on the device and wait for the time to be displayed.
- Push  five times: the display indicates "H 5".
- Push  : the firmware version is indicated, e.g.,
  - "30" = firmware version 3.0
- Push  to end the display.

## 9 Technical Specifications

### Measuring Range

- systolic pressure: 60 to 260 mmHg  
(8.0 to 34.6 kPa)
- diastolic pressure: 40 to 220 mmHg  
(5.3 to 29.3 kPa)
- mean pressure: 50 to 250 mmHg  
(6.7 to 33.3 kPa)
- pulse rate (HR): 35 to 240 min<sup>-1</sup>

### Measurement Accuracy

#### (determined in a clinical study)

- systematic measurement deviation  
for deflation measurement method:
  - 0.2 mmHg (systolic)
  - 0.1 mmHg (diastolic)
- empirical standard deviation  
for deflation measurement method:
  - 2.8 mmHg (systolic)
  - 2.9 mmHg (diastolic)
- systematic measurement deviation  
for inflation measurement method:
  - 0.9 mmHg (systolic)
  - 0.6 mmHg (diastolic)
- empirical standard deviation  
for inflation measurement method:
  - 2.5 mmHg (systolic)
  - 2.3 mmHg (diastolic)

### Measurement Capacity

- up to 400 blood pressure measurements

### Interfaces

- USB (1.1 or 2.0)
- RS-232 (9.600 Bd / 8N1)

### Battery

- 2 AA size rechargeable NiMH batteries, 1.2 V,  
>1500 mAh or
- 2 AA size alkaline batteries

### Battery Charge Time

- 2 to 3 hours

### Maximum Cuff Pressure

- 300 mmHg

### Measurement Method

- oscillometric, selectable measurement method: deflation measurement method or inflation measurement method

### Battery Charger

- protection class II, IP20
- 100 to 240 VAC 50/60 Hz, 0.5 A

### Ambient Conditions

#### Operation

- temperature between +5 and 40°C
- relative humidity between 15 and 93%, no condensation
- atmospheric pressure between 700 hPa (altitude 2800 m above sea level) and 1060 hPa (-400 m above sea level)

#### Note

*The device needs 30 min to get ready for its intended use and reach the operation conditions from the minimum storage temperature and the maximum storage temperature, if the room temperature is 20 °C.*

### Transport and Storage

- temperature between -25 and 70°C
- relative humidity between 10 and 93%, no condensation
- atmospheric pressure between 500 hPa (altitude 4500 m above sea level) and 1060 hPa (-400 m above sea level)

### Dimensions and Weight

- height 27 mm
- width 73 mm
- depth 108 mm
- weight <190 g, incl. batteries

### Protection Class

- IP20: TONOPORT VI
- IP02: wearable pouch of the TONOPORT VI
- IP22: TONOPORT VI in wearable pouch

### Expected Service Life

- TONOPORT VI: 10 years
- Cuff: 20.000 cycles of reapplication

## 10 Order Information

- TONOPOINT VI Ambulatory Blood Pressure System
- TONOPOINT VI recording unit
  - Connection cable TONOPOINT VI to PC (USB)
  - Connection cable TONOPOINT VI to PC (RS232)
  - Battery charger
  - Rechargeable NiMH batteries (4, size AA)
  - Wearable pouch
  - Belt for wearable pouch
  - Blood pressure cuff for adults, standard, for circumference between 24 and 32 cm, Rectus connector
  - TONOPOINT VI Operator Manual
  - CardioSoft CD
  - USB driver CD

## Accessories

- |             |   |
|-------------|---|
| 2001589-041 | Battery charger   |
| 2001589-014 | Rechargeable NiMH battery (device requires 2)   |
| 737 000 08  | Alkaline battery, 1.5 V (device requires 2, size AA)  |
| 2001589-215 | Wearable pouch  |
| 2001589-216 | Belt for wearable pouch   |
| 2001589-040 | Connection cable TONOPOINT VI to PC (USB), length approx. 1.5 meters                                  |
| 2001589-011 | Connection cable TONOPOINT VI to PC (RS232), length approx. 1.2 meters                                |
| 2001589-212 | Blood pressure cuff for adults, standard, for circumference between 24 and 32 cm, Rectus connector    |
| 2001589-211 | Blood pressure cuff for adults, small, for circumference between 17 and 26 cm, Rectus connector       |
| 2001589-213 | Blood pressure cuff for adults, large, for circumference between 32 and 42 cm, Rectus connector       |
| 2001589-214 | Blood pressure cuff for adults, extra large, for circumference between 38 and 46 cm, Rectus connector |
| 2001589-093 | USB driver CD   |

## 11 Appendix—Electromagnetic Compatibility (EMC)

Changes or modifications to this system not expressly approved by GE Healthcare could cause EMC issues with this or other equipment. This system is designed to comply with applicable regulations regarding EMC. Its compliance with these requirements has been verified. It needs to be installed and put into service according to the EMC information stated as follows.

**Warning**

*Use of portable telephones or other radio frequency (RF) emitting equipment near the system may cause unexpected or adverse operation.*

**Warning**

*The equipment or system should not be used adjacent to, or stacked with, other equipment. If adjacent or stacked use is necessary, the equipment or system should be tested to verify normal operation in the configuration in which it is being used.*

**Guidance and Manufacturer’s Declaration—Electromagnetic Emissions**

TONOPORT VI is intended for use in the electromagnetic environment specified below. It is the responsibility of the customer or user to ensure that TONOPORT VI is used in such an environment.

Emissions Test	Compliance	Electromagnetic Environment—Guidance
RF emissions to EN 55011/ CISPR 11	Group 1	TONOPORT VI uses RF energy only for its internal function. Therefore, its RF emissions are very low and are not likely to cause any interference in nearby electronic equipment.
RF emissions to EN 55011/ CISPR 11	Class B	TONOPORT VI is suitable for use in all establishments, including domestic and those directly connected to the public low-voltage power supply network that supplies buildings used for domestic purposes.
Harmonic emissions to EN 61000-3-2/IEC 61000-3-2	not applicable	
Voltage fluctuations/flicker emissions to EN 61000-3-3/ IEC 61000-3-3	not applicable	



<b>Guidance and Manufacturer's Declaration—Electromagnetic Immunity</b>			
TONOPORT VI is intended for use in the electromagnetic environment specified below. It is the responsibility of the customer or user to ensure that TONOPORT VI is used in such an environment.			
<b>Immunity Test</b>	<b>EN/IEC 60601 Test Level</b>	<b>Compliance Level</b>	<b>Electromagnetic environment— Guidance</b>
Electrostatic discharge (ESD) to EN 61000-4-2/ IEC 61000-4-2	± 6 kV contact ± 8 kV air	± 6 kV ± 8 kV	Floors should be wood, concrete or ceramic tile. If floors are covered with synthetic material, the relative humidity should be at least 30%.
Electrical fast transient/ burst to EN 61000-4-4/ IEC 61000-4-4	± 2 kV for power supply lines	not applicable	Mains power should be that of a typical commercial or hospital environment.
	± 1 kV for input/output lines	not applicable	
Surge to EN 61000-4-5/ IEC 61000-4-5	± 1 kV differential mode	not applicable	Mains power should be that of a typical commercial or hospital environment.
	± 2 kV common mode	not applicable	
Voltage dips, short interruptions and voltage variations on power supply input lines to EN 61000-4-11/IEC61000-4-11	< 5% $U_T$ (95% dip in $U_T$ ) for 0.5 cycles	not applicable	Mains power should be that of a typical commercial or hospital environment. If the user of TONOPORT VI requires continued operation during power mains interruptions, it is recommended that TONOPORT VI be powered from an uninterruptible power supply or a battery.
	40% $U_T$ (60% dip in $U_T$ ) for 5 cycles	not applicable	
	70% $U_T$ (30% dip in $U_T$ ) for 25 cycles	not applicable	
	< 5% $U_T$ (> 95% dip in $U_T$ ) for 5 s	not applicable	
Power frequency (50/60 Hz) magnetic field to EN 61000-4-8/IEC 61000-4-8	3 A/m	3 A/m	Power frequency magnetic fields should be at levels characteristic of a typical location in a typical commercial or hospital environment.
NOTE	$U_T$ is the AC mains voltage prior to application of the test level.		

Guidance and Manufacturer's Declaration—Electromagnetic Immunity			
TONOPORT VI is intended for use in the electromagnetic environment specified below. It is the responsibility of the customer or user to ensure that TONOPORT VI is used in such an environment.			
Immunity Test	EN/IEC 60601 Test Level	Compliance Level	Electromagnetic environment—Guidance
<p>Conducted RF to EN 61000-4-6/7IEC 61000-4-6</p> <p>Radiated RF to EN 61000-4-3/IEC 61000-4-3</p>	<p>3 Vrms 150 kHz to 80 MHz</p> <p>3 V/m 80 MHz to 2.5 GHz</p>	<p>3 Vrms</p> <p>3 V/m</p>	<p>Portable and mobile RF communications equipment should be used no closer to any part of TONOPORT VI, including cables, than the recommended separation distance calculated from the equation applicable to the frequency of the transmitter.</p> <p><b>Recommended separation distance:</b></p> $d = 1.17\sqrt{P}$ $d = 1.17\sqrt{P} \text{ at } 80 \text{ MHz to } 800 \text{ MHz}$ $d = 2.33 \sqrt{P} \text{ at } 800 \text{ MHz to } 2.5 \text{ GHz}$ <p>where <math>P</math> is the maximum output power rating of the transmitter in watts (W) according to the transmitter manufacturer and <math>d</math> is the recommended separation distance in meters (m).</p> <p>Field strengths from fixed RF transmitters, as determined by an electromagnetic site survey<sup>a</sup>, should be less than the compliance level in each frequency range<sup>b</sup>.</p> <p>Interference may occur in the vicinity of equipment marked with the following symbol</p> 
NOTE 1 At 80 MHz and 800 MHz, the higher frequency range applies.			
NOTE 2 These guidelines may not apply in all situations. Electromagnetic propagation is affected by absorption and reflection from structures, objects, and people.			
<p>a) Field strengths from fixed transmitters, such as base stations for radio (cellular/cordless) telephones and land mobile radio, AM and FM radio broadcast and TV broadcast cannot be predicted theoretically with accuracy. To assess the electromagnetic environment due to fixed RF transmitters, an electromagnetic site survey should be considered. If the measured field strength in the location in which TONOPORT VI is used exceeds the applicable RF compliance level above, TONOPORT VI should be observed to verify normal operation. If abnormal performance is observed, additional measures may be necessary, such as reorienting or relocating the equipment.</p> <p>b) Over the frequency range from 150 kHz to 80 MHz, field strengths should be less than 3 V/m.</p>			

**Recommended separation distances between portable and mobile RF communications equipment and TONOPORT VI**

TONOPORT VI is intended for use in the electromagnetic environment in which radiated RF disturbances are controlled. The customer or the user of TONOPORT VI can help prevent electromagnetic interference by maintaining a minimum distance between portable and mobile RF communications equipment (transmitters) and TONOPORT VI as recommended below, according to the maximum output power of the communications equipment.

Rated Maximum Output Power of Transmitter [W]	Separation distance According to Frequency of Transmitter [m]		
	150 kHz to 80 MHz $d = 1.17 \sqrt{P}$	80 MHz to 800 MHz $d = 1.17 \sqrt{P}$	800 MHz to 2.5 GHz $d = 2.33 \sqrt{P}$
<b>0.01</b>	<b>0.12</b>	<b>0.12</b>	<b>0.24</b>
<b>0.1</b>	<b>0.37</b>	<b>0.37</b>	<b>0.74</b>
<b>1</b>	<b>1.17</b>	<b>1.17</b>	<b>2.34</b>
<b>10</b>	<b>3.69</b>	<b>3.69</b>	<b>7.38</b>
<b>100</b>	<b>11.67</b>	<b>11.67</b>	<b>23.34</b>

For transmitters rated at a maximum output power not listed above, the recommended separation distance  $d$  in meters (m) can be estimated using the equation applicable to the frequency of the transmitter, where  $P$  is the maximum output power rating of the transmitter in watts (W) according to the transmitter manufacturer.

NOTE 1 At 80 MHz and 800 MHz, the higher frequency range applies.

NOTE 2 These guidelines may not apply in all instances. Electromagnetic propagation is affected by absorption and reflection from structures, objects and people.

## Compliant Cables and Accessories

**Warning**

*The use of accessories, transducers and cables other than those specified may result in increased emissions or decreased immunity performance of the equipment or system.*

The list below shows the accessories that have been tested and found EMC compliant for use with TONOPORT VI.

**Note**

*Any supplied accessories that would not affect electromagnetic compatibility (EMC) are not included.*

- 2001589-011 Connection cable TONOPORT VI to PC (RS232), length of 1.2 meters
- 2001589-040 Connection cable TONOPORT VI to PC (USB), length of 1.5 meters

**A**  
Accessories 31  
Ambient conditions 30  
Audio signal, enable/disable 17

**B**  
Batteries 12  
Batteries, insert 12  
Biocompatibility 6

**C**  
Cables, cleaning 28  
CardioSoft 6  
Caution 4  
CE marking 4  
Charge batteries 13  
Checks before each use 28  
Cleaning 28  
Cleaning agents 28  
Clear memory 16  
Cuff 7  
Cuff application 19  
Cuff cleaning 18  
Cuff size 19  
Cuff tubing 18

**D**  
Danger 4, 8  
Date, set 17  
Day and night phases, toggling 23  
Day phase 21  
Deflation measurement method 6, 23  
Dimensions 30  
Disinfectants 28  
Disposal 29

**E**  
Electromagnetic compatibility 32  
EMC requirements 9  
Energy source, select 12  
Error codes 25  
Explosion hazard 8

**F**  
Firmware version, view 28  
Functional description 7

**G**  
General Information 4

**I**  
Indicators 10  
Inflation measurement method 7, 23  
Inflation Measurement Technology 7  
Information for patients 21, 39  
Intended Use 6  
Interfacing with other equipment 8

**M**  
Maintenance 28  
MDD 4  
Measurement method 6  
Measurement method, select 16  
Measurement protocol, select 17  
Memory, clear 16

**N**  
Night and day phases, toggling 23  
Night phase 21  
NiMH batteries, charge 13

**O**  
Operating controls 10  
Order information 31

**P**  
Patient information 21, 39  
Performance check 15  
Port check 27  
Power 12  
Protocol 21

**R**  
Rechargeable batteries 12

**S**  
Safety information 8  
Self-test 15  
Setup 12  
Software installation 26  
Switching off 15  
Switching on 15  
Symbols used on the battery charger 11

---

Symbols used on the cuff 18  
Symbols used on the display 11  
Symbols used on the equipment 11  
Symbols used on the packaging 11

## **T**

Technical inspections of the measuring system 28  
Technical safety inspections 28  
Technical specifications 30  
Time, set 17  
Toggling between night and day phases 23  
Trial measurement 21

## **U**

USB driver installation 26

## **W**

Warning 4, 8, 9, 19, 20, 21, 24, 28, 29, 32, 36  
Weight 30

## Patient Instructions

### Keep the following points in mind to secure a safe and smooth operation of the device:

During each measurement stay relaxed and minimize your motion to keep the cuff inflation time as short as possible. If you are relaxed the pressure load to your arm will be minimized.



The trail measurement shows you the expected pressure load to your arm during the long term measurement. The pressure load to your arm will vary over the whole day. If the pressure rises far above the expected pressure, you are allowed to deflate the cuff by pressing the  button or just remove the cuff from your arm.

Please note down all important events in a diary to secure a correct interpretation of your blood pressure values by the doctor. Please report all unexpected events or faults to your doctor.

Do not open the battery compartment. Protect the device against water, excessive humidity and do not remove the device from the wearable pouch. You do not have to clean the device after the long term measurement.

Sometimes the device internally stops the long term measurement. In this case deliver the device to the agreed date to your doctor.

The audio signals of the device are disabled by default. If the doctor enables the audio signals, the device will beep after power up procedure and in front of every measurement during day phase.

Place the TONOPORT VI with the wearable pouch on your nightstand while you are sleeping. You are allowed to change the day phase and the night phase manually, if you go to bed before 10 pm or get up before 7 am. To change the phases press the  button once. The results from the last blood pressure measurement are shown. Press the  button once again, while the results are shown. The phase symbol switches from sun to moon or the other way around.

### For your interest:

The device measures your systolic, diastolic and mean arterial blood pressure and your heartrate. The blood pressure is measured with an accuracy  $\pm 3$  mmHg. The device can record up to 400 blood pressure measurements.

### Note down here the additional instructions of your doctor:

# CE-0482



PAR Medizintechnik GmbH & Co. KG  
Sachsendamm 6  
10829 Berlin  
Germany  
Tel: +49 30 2350700  
Fax: +49 30 2138542

GE Medical Systems  
*Information Technologies, Inc.*  
8200 West Tower Avenue  
Milwaukee, WI 53223 USA  
Tel: +1 414 355 5000  
1 800 437 1171 (USA only)  
1 800 668 0732 (Canada only)  
Fax: +1 414 355 3790

GE Medical Systems  
*Information Technologies, GmbH*  
Munzinger Straße 5  
79111 Freiburg  
GERMANY  
Tel: +49 761 4543 - 0  
Fax: +49 761 4543 - 233

Asia Headquarters  
GE (China) Co., Ltd.  
No1 Huatuo Road,  
Zhangjiang Hi-Tech Park Pudong,  
Shanghai, P.R.China 201203  
Tel: +86 21 38777888  
Fax: +86 21 38777402

[www.gehealthcare.com](http://www.gehealthcare.com)

